

CP1 B02

CP1 B02

CP1 B02

CP1 B02

CP1 B02

Installation • Operation • Maintenance

***Adjustable
Frequency
Drives***

***Technical Manual
TM 4340***

M ***MagneTek
Drives & Systems***

CONTENTS

<u>Subject</u>	<u>Page</u>
WARNING / CAUTION STATEMENTS	iii
1 INTRODUCTION	1-1
1.1 General	1-1
1.2 Standard Specifications.....	1-1
1.3 Receiving.....	1-3
2 INSTALLATION	2-1
2.1 Physical	2-1
2.2 Electrical.....	2-4
3 DESCRIPTION OF DIGITAL OPERATOR	3-1
3.1 Pre-Power Checks	3-1
3.2 Initial Start-Up Using Remote Operators	3-1
3.3 Pre-Operation Considerations.....	3-3
3.4 Digital Command Backup	3-3
4 INVERTER ADJUSTMENTS	4-1
4.1 Location of Adjustments	4-1
4.2 Description of Adjustments	4-1
5 OPERATION AT LOAD	5-1
6 MAINTENANCE	6-1
7 FAILURE INDICATION AND DETAILS	7-1
8 TROUBLESHOOTING	8-1
APPENDIX 1 Checking of Diode and Transistor Modules	A1-1
APPENDIX 2 Spare Parts	A2-1
APPENDIX 3 Training	A3-1

When properly installed, operated and maintained, this equipment will provide a life-time of service. It is mandatory that the person who operates, inspects, or maintains this equipment thoroughly read and understand this manual before proceeding.

The Drive is an AC variable speed drive system for high-precision variable speed applications. It basically consists of a three-phase squirrel cage induction motor, a GPD 602 (referred to throughout this manual as the inverter, or unit), an operator control station, and optional control units. This manual primarily describes the inverter, but contains basic information for the operator control station as well. For details of the operation of individual units, refer to their respective manuals.

WARNING

TURN OFF THE AC INPUT POWER AND CONFIRM THAT THE "CHARGE" LAMP IS EXTINGUISHED BEFORE TOUCHING ANY CIRCUIT COMPONENTS. THE CAPACITORS ARE STILL CHARGED AND CAN BE QUITE DANGEROUS.

BEFORE CHANGING SWITCH SETTINGS (1S THRU 6S), TURN OFF THE AC INPUT POWER AND CONFIRM THAT THE "CHARGE" LAMP IS EXTINGUISHED.

DO NOT CONNECT OR DISCONNECT WIRES AND CONNECTORS WHILE POWER IS APPLIED TO THE CIRCUIT.

CAUTION

NEVER CONNECT CAPACITORS ACROSS THE INVERTER OUTPUT AND MOTOR. UPON APPLICATION OF POWER, THE INVERTER INITIALLY SEES THE CAPACITORS AS A SHORT CIRCUIT, HIGH CURRENTS RESULT AND EQUIPMENT WILL BE DAMAGED.

IF REQUIRED, POWER FACTOR CORRECTION CAPACITOR NETWORKS MAY BE CONNECTED ACROSS THE INPUT POWER SOURCE ONLY AFTER CONSULTING THE FACTORY.

IMPROPER USE OF POWER FACTOR CORRECTION CAPACITOR NETWORKS WILL DAMAGE EQUIPMENT.

IMPORTANT

Be sure to ground unit using ground terminal GND(E). See "Grounding" in Section 2.

Never connect main circuit output terminals T1(U), T2(V), T3(W) to AC main circuit power supply.

The inverter has been adjusted at the factory. Changes or adjustments should not be attempted until after reading this manual.

Do not hipot any part of the unit. Equipment uses semi-conductors and is vulnerable to high voltage.

Performing insulation resistance tests with a megger requires special care and safety precautions. See "Insulation Resistance Test" in Section 2.

NOTICE

This equipment is exempted from FCC regulations. See 47CFR15.801.

1. INTRODUCTION

1.1 GENERAL

The inverter is a high performance pulse width modulated (PWM) design which generates a sine-coded, adjustable voltage/frequency three phase output for complete speed control of any conventional squirrel cage induction motor. The inverter can maintain a 150% current overload capability for 60 seconds with automatic stall prevention and voltage boost to prevent nuisance tripping during load or line side transient conditions. The inverter will not induce any voltage line notching distortion back to the utility line and maintains a displacement power factor of not less than .95 throughout its speed range.

1.2 STANDARD SPECIFICATIONS

- ENVIRONMENTAL CONDITIONS

Altitude: To 3300 Feet Above Sea Level

Operating Ambient Temperature:

-10 to 40°C

Storage Temperature: -20 to 60°C

Noncondensing Relative Humidity:

To 90%

Vibration: 1G Max at Less Than 20 Hz,

0.2G Max at 20-50 Hz

- INPUT POWER REQUIREMENTS

Voltage: 230 and 460 VAC versions,
±10%

Phase: 3-Phase, 3-Wire, Phase Sequence
Insensitive

Frequency: 50 or 60 Hz, ± 5%

- NOMINAL OUTPUT

Voltage: To 230 or 460 VAC, 3-Phase
ungrounded

Frequency Range: 1.5-60 Hz, Constant
Volts/Hertz. Constant volts to 180 Hz
user selectable, and 400 Hz available
as an option

Service Factor: 1.0

- STANDARD FEATURES

Frequency Resolution: 0.1 Hz with
digital reference; 0.06 Hz with analog
reference

Frequency Regulation: 0.01% with
digital command (-10 to 40°C); 0.2%
with analog command (25°C, ± 10°C)

Speed Range: 40:1

Remote Speed Reference Capability:

0 - 10 VDC (20K ohms) or 4 - 20mA
(500 ohms)

Efficiency: Over 95% at 60 Hz

Enclosure: Enclosed chassis; NEMA 1
Floor-mount above 75 HP (230V) and
150 HP (460V)

+ 15 VDC Control Circuit

Remote Frequency Meter Terminal

Run and Fault Contacts available for
customer use

- PROTECTIVE FEATURES

Overload Capability: 150% for 60 sec.

Instantaneous Overcurrent Trip

Overvoltage Trip

Undervoltage Trip

Overtemperature Trip

External Fault Indication

Blown Fuse Indication

Control Function Error Indication

DC Bus Fuse

Ground Fault Protection (not available
on 230V units up to 10 HP)

Stall Prevention

Momentary Power Failure Ride-through:

2 seconds (230V); 0.2 seconds (460V)
with option to 2 seconds

- APPLICATION ADJUSTMENTS

Volts/Hertz Ratio: 15 Selectable Patterns
 Accel/Decel Rates: Independently Adjustable; 0.2 - 1800 Seconds

Sequence Mode: Allows for Braking, Bypass, Jog, Torque Limit and other application-related functions
 Operation Mode: Used in conjunction with sequence mode selector to set operation conditions, such as restart after power failure

Table 1. Inverter Ratings

230 VAC INPUT			460 VAC INPUT		
HP	OUTPUT KVA	OUTPUT AMPS	HP	OUTPUT KVA	OUTPUT AMPS
5	6.9	17.3	5	7.4	9.2
7.5	10.6	26.5	7.5	11.0	13.8
10	13.9	34.6	10	14.5	18.1
15	20.8	51.9	15	18.6	23.2
20	24.8	62.0	20	22.7	28.3
25	29.0	72.4	25	29.0	36.2
30	36.3	90.6	30	36.7	45.8
40	43.8	109.2	40	43.5	54.6
50	58.1	144.9	50	58.0	72.4
60	72.8	181.6	60	74.5	93.0
75	87.1	217.3	75	87	108.6
100	102.0	254.1	100	109	136.5
125	145.0	362.2	150	160	199.5
			200	204	254.1
			250	256	320
			300	290	362
			350	344	430
			450	416	520
			500	480	600
			600	576	720

1.3 RECEIVING

This unit has been put through demanding tests at the factory before being shipped. After unpacking, verify the part numbers with the purchase order sheet (invoice). Any damages or shortages evident when the equipment is received must be reported immediately to the commercial carrier who transported the equipment. Assistance, if required, is available from your sales representative.

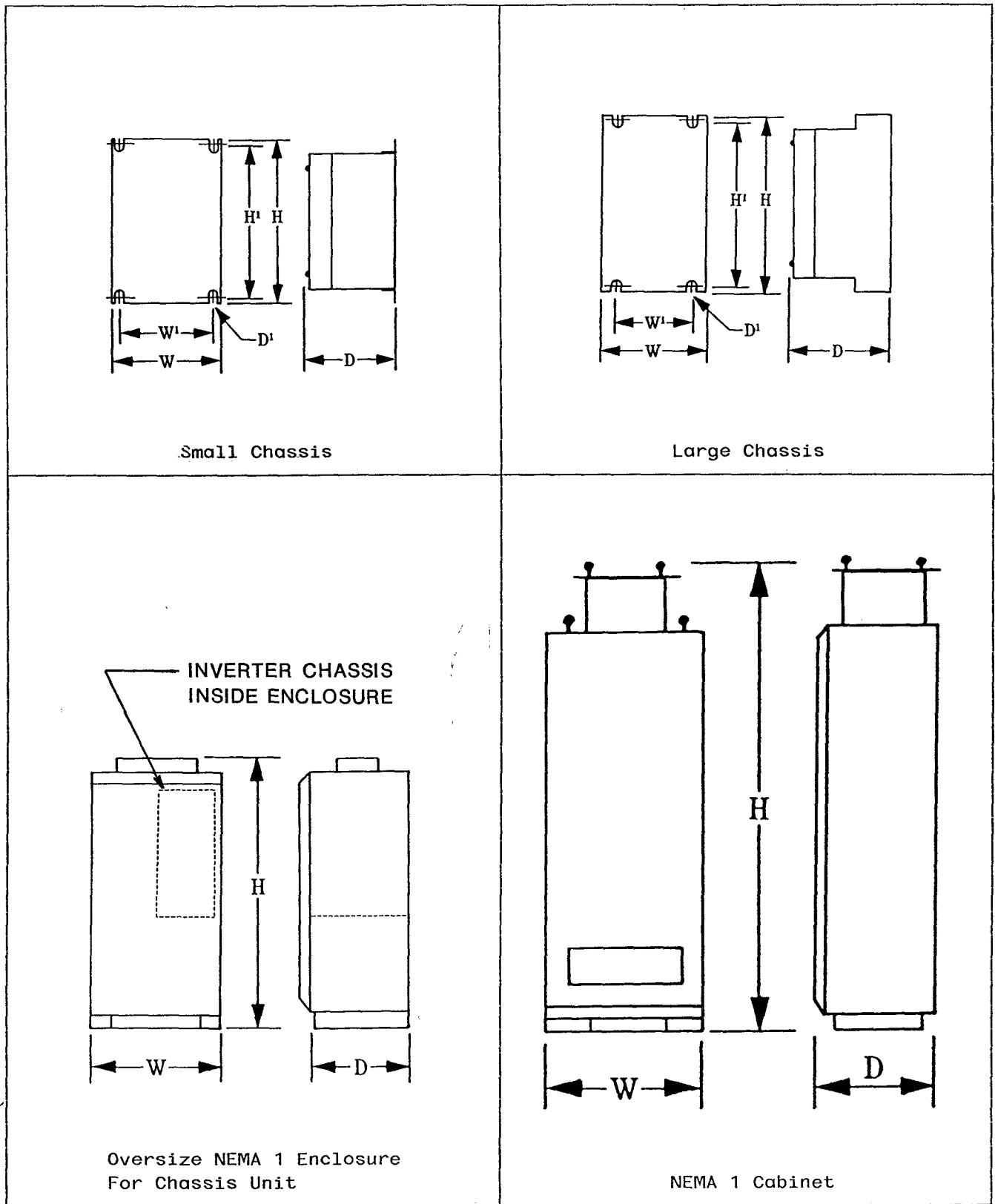

Figure 1. Unit Dimensions

2. INSTALLATION

2.1 PHYSICAL

A. Location and Positioning

Location of the inverter is important to achieve proper performance and normal operating life. The unit should be installed in an area where it will be protected from:

- Direct sunlight, rain or moisture.
- Corrosive gases or liquids.
- Vibration, airborne dust or metallic particles.

CAUTION

NEVER MOVE, LIFT OR HANDLE THE UNIT BY THE FRONT COVER.

For effective cooling as well as proper maintenance, the unit must be installed vertically to the ground using the four mounting screws. There **MUST** be a **MINIMUM 6 in.** clearance above and below the unit. A **MINIMUM 2 in.** clearance is also required on each side on the unit.

B. Standard Dimensions

Table 2. Unit Size and Weight

UNIT RATING		UNIT STYLE (FIGURE 1)	PHYSICAL DIMENSIONS (IN.)			MOUNTING HOLE DIM. (IN.)			WEIGHT (LB.)
VOLTS	HP		H	W	D	H1	W1	(DIA) D1	
230	5	SMALL CHASSIS *	11.81	7.87	8.07	11.42	6.89	0.187	25
	7.5, 10 15 20-40 50-75	LARGE CHASSIS *	13.78	7.87	8.46	13.39	4.92	0.187	35
			19.69	9.84	10.04	19.09	7.87	0.234	48
			21.65	12.80	10.04	21.06	10.83	0.234	70
31.50	18.70	11.02	30.71	14.76	0.390	140			
100. 125	NEMA 1 CABINET	98.82	31.50	23.62	–	–	–	1350	
460	5	SMALL CHASSIS *	13.78	7.87	9.25	13.39	6.89	0.187	34
	7.5, 10		15.75	7.87	11.42	15.35	6.89	0.187	50
	15-25 30, 40 50-75 100-200	LARGE CHASSIS *	19.69	9.84	12.00	19.09	7.87	0.234	60
			21.65	12.80	10.04	21.06	10.43	0.234	70
			28.54	13.78	11.02	27.76	9.84	0.312	118
36.42	22.64	11.02	35.43	18.70	0.468	218			
250-350 450-600	NEMA 1 CABINET	91.89 93.70	31.50 86.61	23.62 31.50	– –	– –	– –	1350 2900	

* For chassis units with oversize NEMA 1 enclosure option, see dimensions in Table 2A.

Table 2A. Optional NEMA 1 Enclosure Dimensions

HP (1)	H	W	D (2)
5-10	17.70	31.50	9.50/13.00
15-40	22.00	45.30	11.80/13.00
50-75	25.60	57.10	13.00
100-200 (460V ONLY)	29.50	65.00	13.00

- (1) Indicated HP applies to 230V or 460V unless specified.
- (2) Where two dimensions are given, they are for 230V/460V.

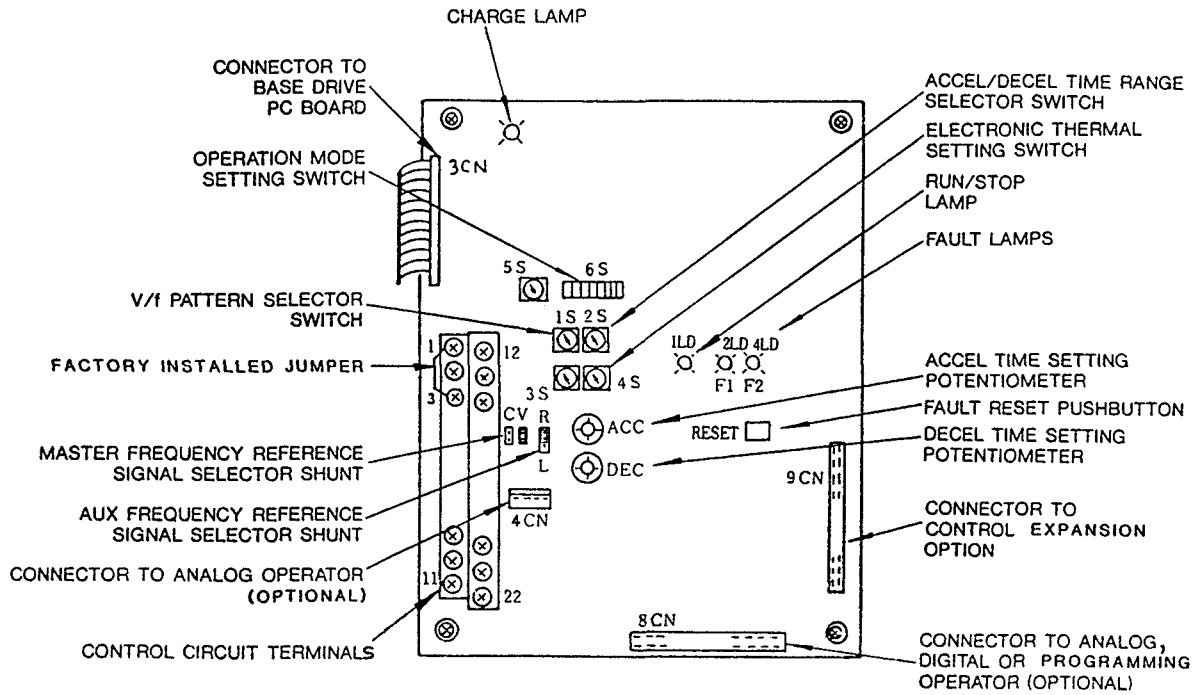

Figure 2A. Control PCB (1PCB)

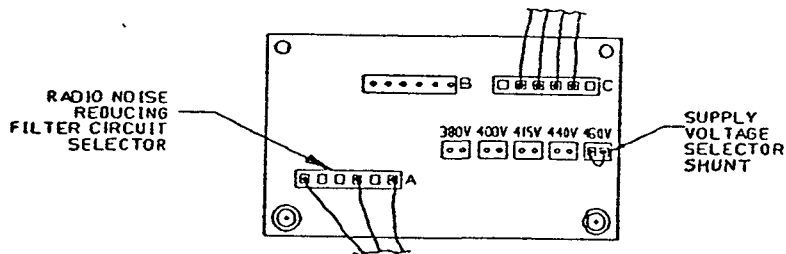

Figure 2B. Voltage Selecting PC Board (3PCB), in 460V Units.

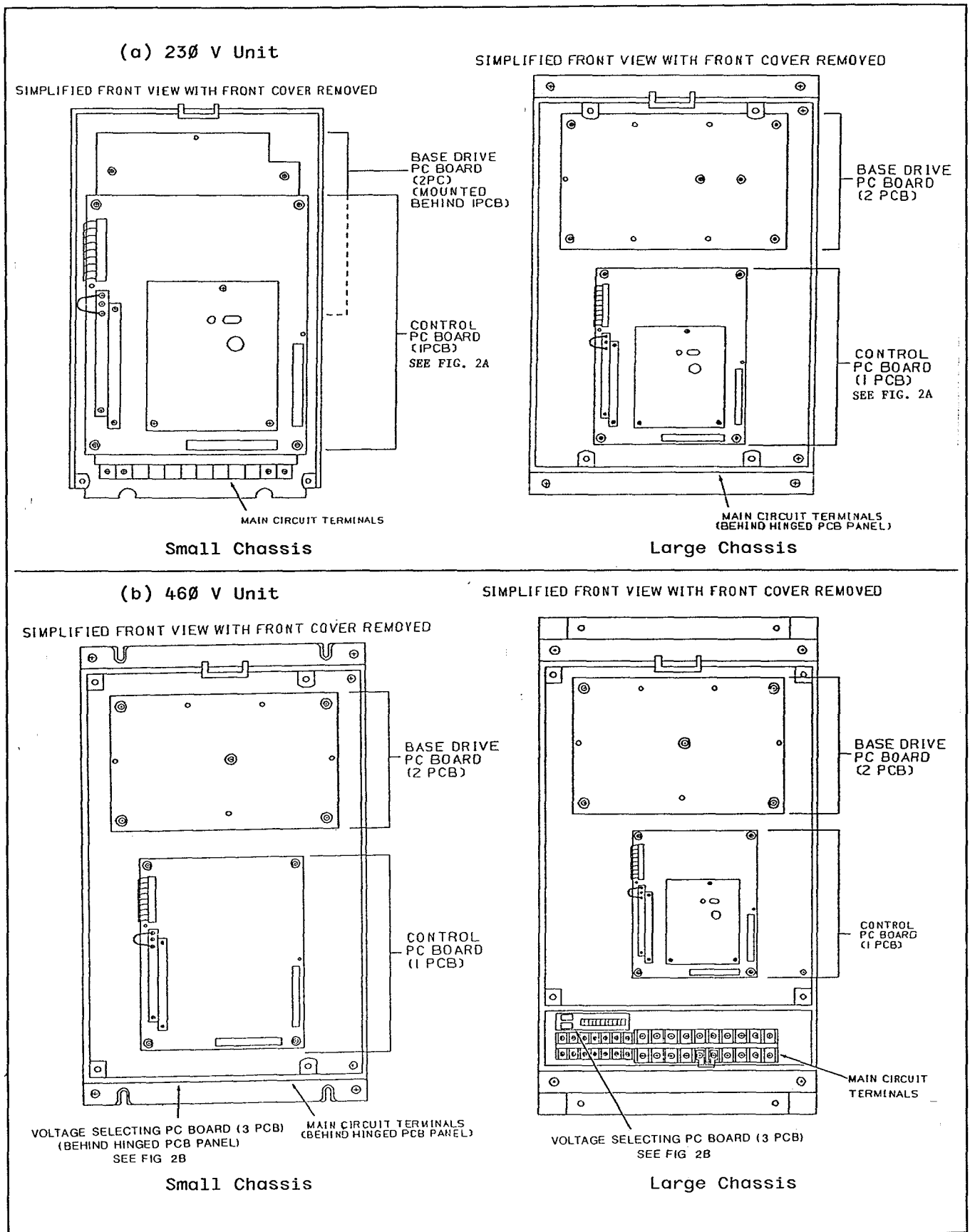

Figure 2C. Major Control Component Location

2.2 ELECTRICAL

A. Interconnections

All interconnections required for initial start-up, using external ("remote") control inputs, are shown in Figure 6.

B. Wiring Instructions

Remove the inverter front cover for access to terminals.

1. Main Circuit Input/Output

Complete wiring interconnections for the main circuit according to Tables 3 and 4, while observing the following precautions.

- Use 600V vinyl-sheathed lead or equivalent. Wire size should be determined considering voltage drop of leads.
- NEVER connect AC main power to output terminals T1(U), T2(V), and T3(W).
- NEVER allow wire leads to contact inverter enclosure. Short-circuit may result.
- NEVER connect power factor correction capacitors or noise filter to unit output.

Table 3. Wire Sizing For Main Circuit

TERMINAL SYMBOL	230V UNITS			460V UNITS		
	HP RATING	TERMINAL SCREW	WIRE SIZE AWG	HP RATING	TERMINAL SCREW	WIRE SIZE AWG
GND (E)	ALL	M4	14-10	ALL	M4	14-10
L1(R), L2(S), L3(T), T1(U), T2(V), T3(W)	5	M4	12-10	5	M4	14-10
	7.5	M4	10-8	7.5, 10	M4	12-10
	10	M5	10-8	15-25	M5	10-8
	15-30	M6	8-6	30, 40	M6	8-6
	40, 50	M8	4-1	50-75	M8	4-1
	60	M10	2-4/0	100	M10	2-4/0
	75-125	M10	1/0-4/0	150	M10	1/0-4/0
	-	-	-	200-300	M12	4/0 MCM300 MCM400
	-	-	-	350-600	M12	MCM650 (2 PAIR)

Table 4. Terminal Functions and Voltages of Main Circuit

SECTION A. 5 - 10 HP, 230V UNITS		
TERMINAL	FUNCTION	LEVELS
L1, L2, L3	MAIN CIRCUIT INPUT POWER SUPPLY	THREE PHASE 208 - 230 VAC, 50/60HZ (VOLTAGE FLUCTUATION ± 10%)
H1, H2	COOLING FAN INPUT POWER SUPPLY	SINGLE PHASE (FROM INPUT POWER SUPPLY)
T1, T2, T3	OUTPUT TO MOTOR	THREE PHASE 208 - 230 VAC MAXIMUM (CORRESPONDING TO INPUT VOLTAGE)
B1, B2, a, b	BRAKING MODULE (INTERNAL MOUNTING OPTION)	0 TO APPROXIMATELY 300 VDC
B3, N-	OUTPUT TO BRAKING RESISTOR UNIT (NOTE 1)	
P+ to N-	DC BUS VOLTAGE FROM MAIN CIRCUIT	APPROXIMATELY 300 VDC
GND	GROUND TERMINAL	
SECTION B. 15 - 125 HP, 230V UNITS		
TERMINAL	FUNCTIONS	LEVELS
L1, L2, L3	MAIN CIRCUIT INPUT POWER SUPPLY	THREE PHASE 208 - 230 VAC, 50/60HZ (VOLTAGE FLUCTUATION ± 10%)
H1, H2	COOLING FAN INPUT POWER SUPPLY	SINGLE PHASE (FROM INPUT POWER SUPPLY)
T1, T2, T3	OUTPUT TO MOTOR	THREE PHASE 208 - 230 VAC MAXIMUM (CORRESPONDING TO INPUT VOLTAGE)
P1 to N-	OUTPUT TO BRAKING UNIT (NOTE 2)	0 TO APROXIMATELY 300 VDC
P1, P2, P3 to N-	DC BUS VOLTAGE FROM MAIN CIRCUIT	APPROXIMATELY 300 VDC
GND	GROUND TERMINAL	
SECTION C. 5 - 150 HP, 460V UNITS		
TERMINAL	FUNCTIONS	LEVELS
L1, L2, L3	MAIN CIRCUIT INPUT POWER SUPPLY	THREE PHASE 380 - 460 VAC, 50/60HZ (VOLTAGE FLUCTUATION ± 10%)
H1, H2	CONTROL CIRCUIT INPUT POWER SUPPLY	SINGLE PHASE (FROM INPUT POWER SUPPLY)
T1, T2, T3	OUTPUT TO MOTOR	THREE PHASE 380 - 460 VAC MAXIMUM (CORRESPONDING TO INPUT VOLTAGE)

Table 4. Terminal Functions and Voltages of Main Circuit - Continued

SECTION C. 5 - 150 HP, 460V UNITS - Continued		
TERMINAL	FUNCTIONS	LEVELS
P1, P2	DC REACTOR FOR POWER FACTOR CORRECTION	
P3 to N-	EXTERNAL CAPACITOR (UP TO THE SAME CAPACITY OF CAPACITOR INCORPORATED IN INVERTER)	APPROXIMATELY 600 VDC
P1 to N-	OUTPUT TO BRAKING UNIT (NOTE 2)	0 TO APPROXIMATELY 600 VDC
P1, P2, N-	DC BUS VOLTAGE FROM MAIN CIRCUIT	APPROXIMATELY 600 VDC
C1, C2	BACKUP CAPACITOR FOR MOMENTARY FAILURE	APPROXIMATELY 300 VDC
V1, V2	POWER SUPPLY TO EXTERNAL EQUIPMENT	220 VAC, 50/60HZ
GND	GROUND TERMINAL	
SECTION D. 200 - 600 HP, 460V UNITS		
TERMINAL	FUNCTIONS	LEVELS
L1, L2, L3	MAIN CIRCUIT INPUT POWER SUPPLY	THREE PHASE 380 - 460 VAC, 50/60HZ (VOLTAGE FLUCTUATION \pm 10%)
<i>l1, l2, l3</i>	CONTROL CIRCUIT INPUT POWER SUPPLY	THREE PHASE (FROM INPUT POWER SUPPLY)
T1, T2, T3	OUTPUT TO MOTOR	THREE PHASE 380 - 460 VAC MAXIMUM (CORRESPONDING TO INPUT VOLTAGE)
P1, P2	DC REACTOR FOR POWER FACTOR CORRECTION	
P3 to N	EXTERNAL CAPACITOR (UP TO THE SAME CAPACITY OF CAPACITOR INCORPORATED IN INVERTER)	APPROXIMATELY 600 VDC
P1 to N	OUTPUT TO BRAKING UNIT (NOTE 2)	0 TO APPROXIMATELY 600 VDC
P1, P2, N	DC BUS VOLTAGE FROM MAIN CIRCUIT	APPROXIMATELY 600 VDC
C1, C2	BACKUP CAPACITOR FOR MOMENTARY POWER FAILURE	APPROXIMATELY 300 VDC
V1, V2	POWER SUPPLY TO EXTERNAL EQUIPMENT	220 VAC, 50/60HZ
GND	GROUND TERMINAL	

NOTES:

1. External option, used with braking module.
2. External option.

2. Control Circuit

All control circuit (signal) interconnections required for initial start-up are shown in the appropriate diagram (Figure 6A or 6B).

Make wiring connections according to the diagram and Table 5, observing the following precautions:

- Use **twisted shielded or twisted-pair shielded wire, 20-14 AWG (0.5-2mm²), for all control circuit leads**. Wire size should be determined considering voltage drop in leads. See Figure 3: connect shield sheath **AT THE INVERTER END ONLY**; the far end should be dressed neatly and left unconnected.

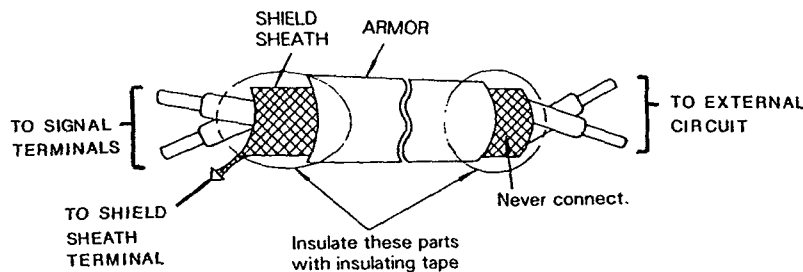

Figure 3. Shielded Sheath Termination

- **Signal leads 1 thru 22 must be separated from main circuit leads L1(R), L2(S), L3(T), T1(U), T2(V), T3(W) and any other power cables, to prevent erroneous operation caused by noise interference.**
- Control circuit leads 12 thru 16 (relay contact output) must be separated from leads 1-11 and 17-22.
- Lead length should NOT EXCEED 164 feet (50 meters).

3. Grounding

The inverter must be solidly grounded using main circuit ground terminal GND(E).

- Ground resistance should be 100 ohms or less.
- NEVER ground the unit in common with welding machines, motors, or other large-current electrical equipment. Run the ground lead in a separate conduit from leads for large-current electrical equipment.
- Use ground lead size listed in Table 3, and make the length as short as possible.

Table 5. Terminal Functions and Signals of Control Circuit

TERMINAL	FUNCTIONS	LEVELS
1	CONTROL CIRCUIT INPUT COMMON	COMMON
2	RUN SIGNAL	RUN WHEN CLOSED*
3	STOP SIGNAL	STOP WHEN OPEN*
4	CONNECTION TO SHIELD OF SIGNAL LEAD	GND.
5	FWD/REV OPERATION	FORWARD WHEN OPEN, REVERSE WHEN CLOSED
6	AUTO/MAN FREQUENCY SIGNAL SELECTOR	AUTO WHEN OPEN, MANUAL SPEED WHEN CLOSED
7	EXTERNAL FAULT INPUT	EXTERNAL FAULT WHEN CLOSED*; WILL INITIATE "EB" FAULT INDICATION
8	FAULT RESET INPUT (EXTERNAL)	FAULT RESET WHEN CLOSED*
9	"AUTO" MODE FREQUENCY SIGNAL INPUT	0 to +10V (20K Ω) or 4 - 20 MA (500 Ω)
10		COMMON
11	CONNECTION TO SHIELD OF SIGNAL LEAD	GND.
12 13	RUN CONTACT OUTPUT (1 N.O.) CLOSED DURING RUN	CONTACT CAPACITY: 250 VAC at 1A 30 VDC at 1A
14 COM 15 N.C. 16 N.O.	FAULT CONTACT OUTPUT (FORM C) N.C. OPEN AT FAULT N.O. CLOSED AT FAULT	CONTACT CAPACITY: 250 VAC at 1A 30 VDC at 1A
17	FREQUENCY METER	APPROXIMATELY +10V / 100%, OUTPUT IMPEDANCE, 3K Ω
18		COMMON
19	CONNECTION TO SHIELD OF SIGNAL LEAD	GND.
20	+15 VDC OUTPUT (20MA MAX)	REGULATED POWER SUPPLY
21	"MAN" MODE FREQUENCY SIGNAL INPUT	0 to 10 VDC
22		COMMON

* Operation after a momentary pulse input greater than 40ms.

3. Grounding (continued)

- Where several units are used side by side, all units should be grounded directly to the ground poles. However, it is permissible to connect all the ground terminals in parallel and ground only one unit to the ground pole (see Figure 4). DO NOT FORM A LOOP WITH THE GROUND LEADS.

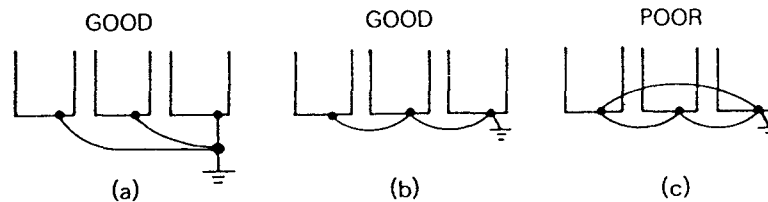

Figure 4. Grounding of Three Units

4. Insulation Resistance Test

CAUTION

NEVER MEASURE THE INSULATION RESISTANCE OF CIRCUITS OTHER THAN THE MAIN CIRCUIT.

For megger-testing the main circuit, measure the insulation resistance with a 500V megger. (See Figure 5).

- Use a common wire to short together all main circuit terminals except GND(E).
- Use a common wire to short together all Control PCB terminals except 4, 11 and 19.
- Measure the insulation resistance between the main circuit terminals and ground (terminal GND). A reading above 1 meg-ohm is considered satisfactory.

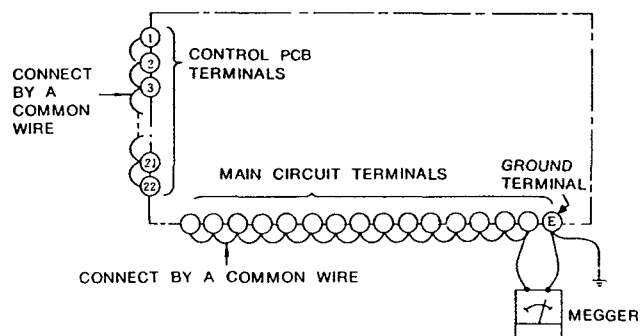

Figure 5. Connections for Megger Testing

NOTES FOR FIGURE 6A

* - INDICATES COMPONENTS NOT SUPPLIED.

□ - INDICATES CUSTOMER CONNECTION TERMINAL. WIRE ONLY TO TERMINALS SHOWN.

() - INDICATES ALTERNATE TERMINAL MARKING, I.E., (R) AND L1.

▲ - FUNCTION LABEL SHOWN FOR THESE TERMINALS ARE DETERMINED BY FACTORY SETTING OF 3S.

1. THE SWITCHES INDICATE FACTORY SETTINGS. 1S CHANGES THE V/HZ PROFILE, WITH A MAXIMUM SETTING OF 180 HZ. 2S CHANGES ACCEL/DECEL TIME RANGE. 5S AND 6S(8) ARE DEPENDENT ON DRIVE CAPACITY AND INPUT VOLTAGE RESPECTIVELY; SEE TABLES 10 AND 11.
2. AUTO FREQUENCY REFERENCE SHUNT IS FACTORY SET FOR 0 TO 10V INPUT (V). IF 4-20MA IS DESIRED, MOVE SHUNT TO (C) POSITION.
3. TERMINAL 13(t) ONLY APPLIES TO 460V, 125 TO 600 HP UNITS. TERMINALS 11(r) and 12(s) ARE NOT AVAILABLE ON 230V, 5 HP UNITS. JUMPERS ARE FACTORY INSTALLED.
4. WHEN REMOTE STOP INPUT IS USED, REMOVE FACTORY INSTALLED JUMPER BETWEEN TERMINALS 1 AND 3.
5. IF ONLY A REMOTE MANUAL SPEED POT (1RH) IS USED, 2SS IS NOT NEEDED. JUMPER MUST BE ADDED BETWEEN TERMINALS 1 AND 6.
6. THE INVERTER DOES NOT CONTAIN OVERLOAD 10L; 10L IS A SEPARATE ITEM. ALSO THE CONTACTS FROM THE SEPARATELY SUPPLIED OVERLOAD RELAY SHOULD BE INTERLOCKED WITH THE INVERTER AS SHOWN. IT SHOULD BE THE MANUAL RESET TYPE TO PREVENT AUTOMATIC RESTART FOLLOWING A MOTOR FAULT AND SUBSEQUENT CONTACT RECLOSURE AFTER COOL DOWN.
7. INSULATED TWISTED SHIELDED WIRE IS REQUIRED.
2-CONDUCTOR #18 GA. (BELDON #8760 OR EQUIVALENT).
3-CONDUCTOR #18 GA. (BELDON #8770 OR EQUIVALENT).
CONNECT SHIELD ONLY AT INVERTER END. STUB AND ISOLATE OTHER END.
8. REMOTE OPERATORS, AS SHOWN, MAY NOT BE REQUIRED WHEN EITHER AN ANALOG OR DIGITAL OPERATOR IS PRESENT. WHEN ANALOG OPERATOR IS PRESENT, MANUAL FREQUENCY REFERENCE SHUNT WILL BE IN THE (L) POSITION, WHICH PROHIBITS USE OF REMOTE SPEED POT.
9. CUSTOMER TO CONNECT TERMINAL GND(E) TO EARTH GROUND.

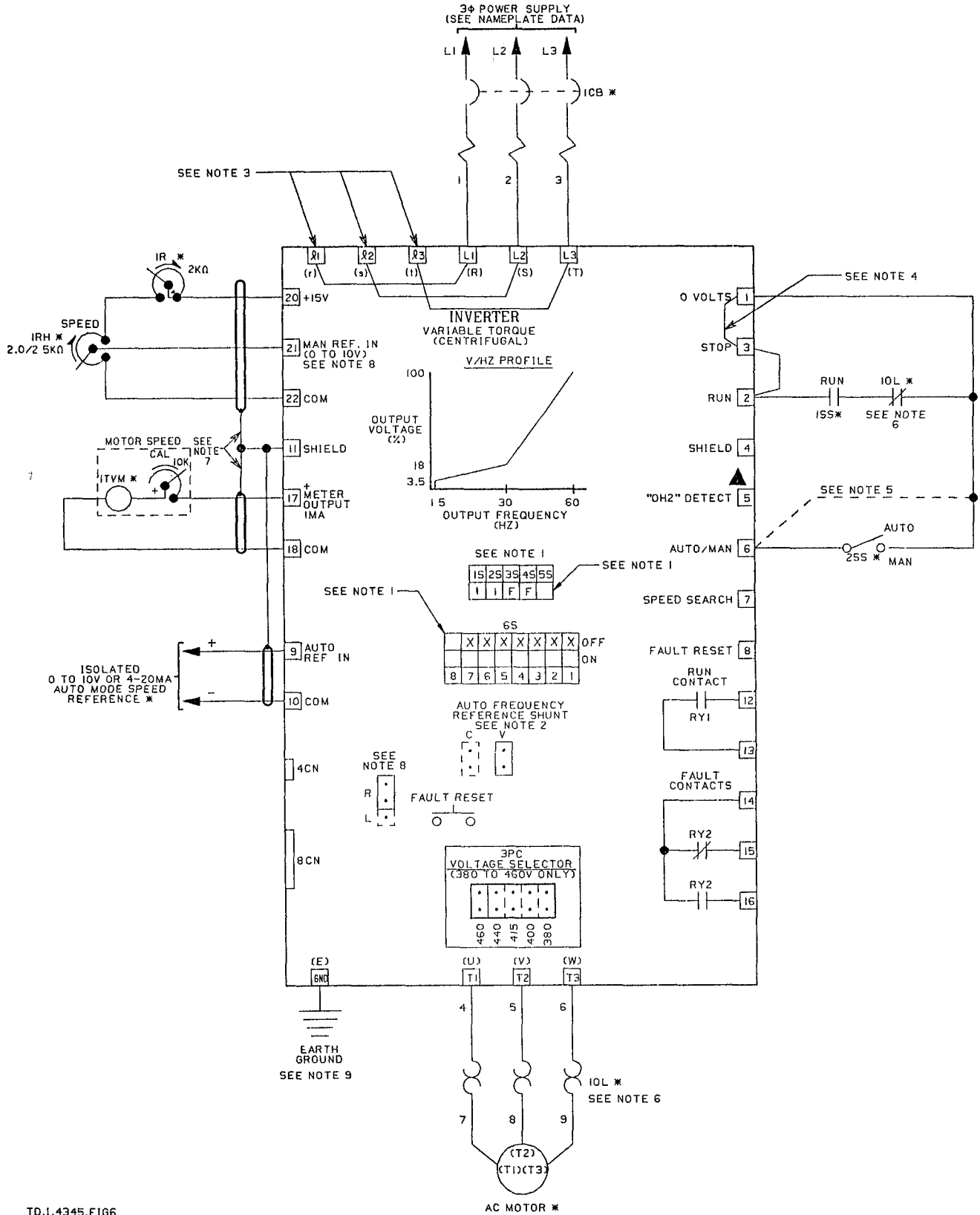

TD.1.4345.F166

Figure 6A. Initial Interconnections - 2-Wire Control

NOTES FOR FIGURE 6B

* - INDICATES COMPONENTS NOT SUPPLIED.

□ - INDICATES CUSTOMER CONNECTION TERMINAL. WIRE ONLY TO TERMINALS SHOWN.

() - INDICATES ALTERNATE TERMINAL MARKING, I.E., (R) AND L1.

▲ - FUNCTION LABEL SHOWN FOR THESE TERMINALS ARE DETERMINED BY FACTORY SETTING OF 3S.

1. THE SWITCHES INDICATE FACTORY SETTINGS. 1S CHANGES THE V/HZ PROFILE, WITH A MAXIMUM SETTING OF 180 HZ. 2S CHANGES ACCEL/DECEL TIME RANGE. 5S AND 6S(8) ARE DEPENDENT ON DRIVE CAPACITY AND INPUT VOLTAGE RESPECTIVELY; SEE TABLES 10 AND 11.
2. AUTO FREQUENCY REFERENCE SHUNT IS FACTORY SET FOR 0 TO 10V INPUT (V). IF 4-20MA IS DESIRED, MOVE SHUNT TO (C) POSITION.
3. TERMINAL 3(t) ONLY APPLIES TO 460V, 125 TO 600 HP UNITS. TERMINALS 1(r) and 2(s) ARE NOT AVAILABLE ON 230V, 5 HP UNITS. JUMPERS ARE FACTORY INSTALLED.
4. WHEN REMOTE STOP INPUT IS USED, REMOVE FACTORY INSTALLED JUMPER BETWEEN TERMINALS 1 AND 3.
5. IF ONLY A REMOTE MANUAL SPEED POT (1RH) IS USED, 2SS IS NOT NEEDED. JUMPER MUST BE ADDED BETWEEN TERMINALS 1 AND 6.
6. THE INVERTER DOES NOT CONTAIN OVERLOAD 10L; 10L IS A SEPARATE ITEM. ALSO THE CONTACTS FROM THE SEPARATELY SUPPLIED OVERLOAD RELAY SHOULD BE INTERLOCKED WITH THE INVERTER AS SHOWN. IT SHOULD BE THE MANUAL RESET TYPE TO PREVENT AUTOMATIC RESTART FOLLOWING A MOTOR FAULT AND SUBSEQUENT CONTACT RECLOSURE AFTER COOL DOWN.
7. INSULATED TWISTED SHIELDED WIRE IS REQUIRED.
2-CONDUCTOR #18 GA. (BELDON #8760 OR EQUIVALENT).
3-CONDUCTOR #18 GA. (BELDON #8770 OR EQUIVALENT).
CONNECT SHIELD ONLY AT INVERTER END. STUB AND ISOLATE OTHER END.
8. REMOTE OPERATORS, AS SHOWN, MAY NOT BE REQUIRED WHEN EITHER AN ANALOG OR DIGITAL OPERATOR IS PRESENT. WHEN ANALOG OPERATOR IS PRESENT, MANUAL FREQUENCY REFERENCE SHUNT WILL BE IN THE (L) POSITION, WHICH PROHIBITS USE OF REMOTE SPEED POT.
9. CUSTOMER TO CONNECT TERMINAL GND(E) TO EARTH GROUND.

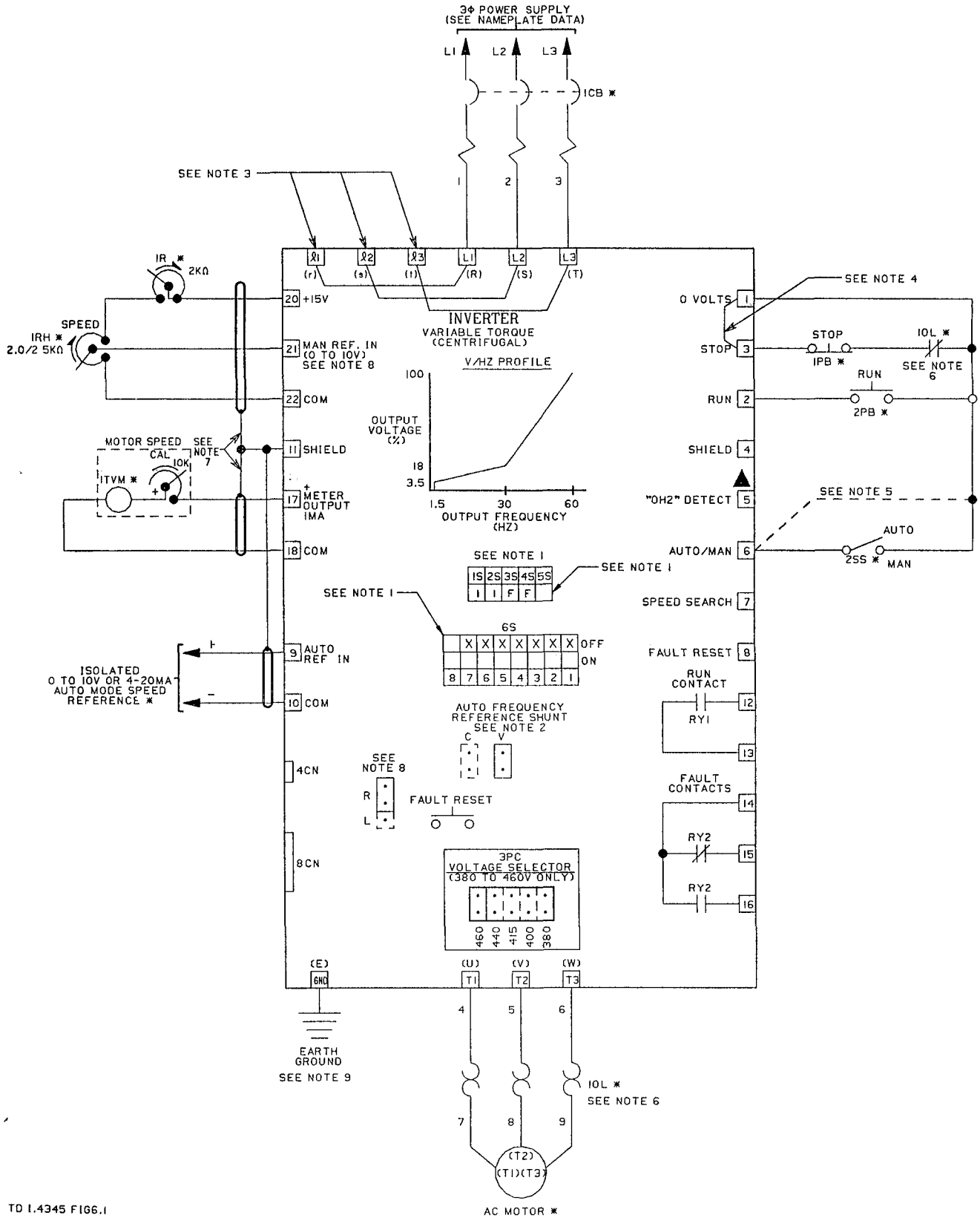

TO I.4345 FIG6.1

Figure 6B. Initial Interconnections - 3-Wire Control

3. INITIAL START-UP

3.1 PRE-POWER CHECKS

- Wires are properly connected and no erroneous grounds exist.
- All debris inside enclosure is removed. Check especially for loose wire clippings.
- All mechanical connections inside unit are tight.
- Motor not connected to load.
- Speed pot set to minimum (CCW).
- For 460V rated Unit only: Check the power voltage selecting shunt in the unit (see Figures 2B and 7). If necessary, reposition to the correct connection for input power being used. Voltage is preset to 460V at the factory.

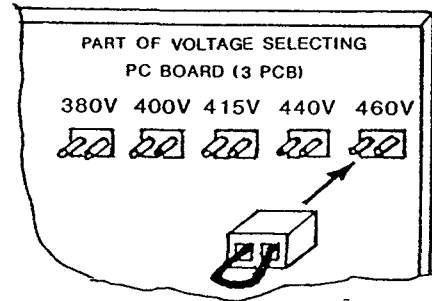

Figure 7. Power Voltage Selection (460V Unit)

3.2 INITIAL START-UP USING REMOTE OPERATORS

The operation described in Table 6 and shown in Figure 8 is for a standard 60 Hz motor.

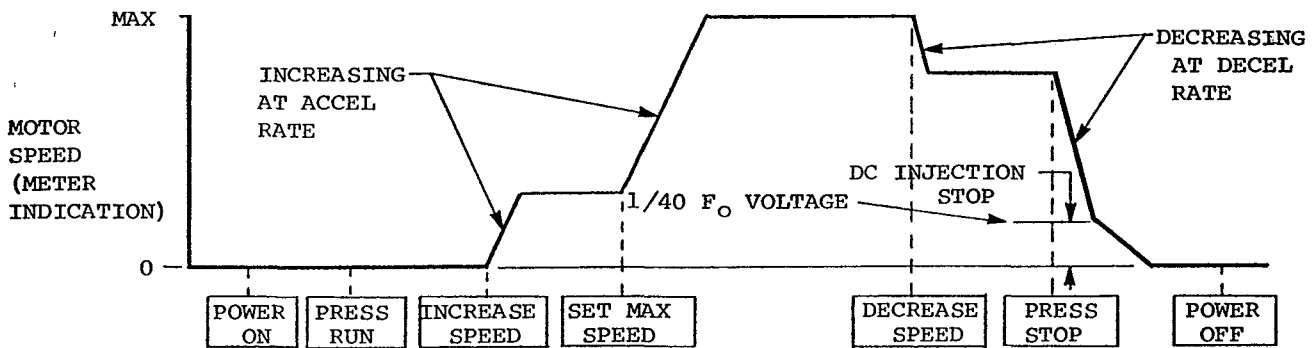

Figure 8. Example of Simple Operation

NOTE

All steps in Table 6 assume that an external control signal input is used (remote OCS or customer system logic). If an optional Analog or Digital Operator is present, controls and indications will be different, according to the description in the option instruction sheet.

Table 6. Initial Start-Up With Remote Operators

STEP	OPERATION	INDICATION	DESCRIPTION
1. Power On	Close input circuit breaker.	"RUN" LED blinks. "CHARGE" LED lights. Speed meter indicates 0.	Drive is ready for operation. Motor is stopped.
2. Start Inverter	Press RUN button.	"RUN" LED lights steadily. Speed meter indicates 0.	Inverter is ready to control motor. Motor is stopped.
3. Increase Speed	Turn SPEED pot CW to medium setting.	Motor begins to turn in reverse direction. Meter indication increases with motor speed.	Inverter output increases at set accel rate until motor reaches set speed.
4. Run at Maximum Speed	Increase SPEED pot to fully CW.	Motor speed increases, then settles at maximum. Meter indication follows motor speed.	Inverter output increases to maximum to produce maximum motor speed.
5. Decrease Speed	Turn SPEED pot CCW to a lower setting.	Motor speed drops. Meter indication follows motor speed.	Inverter output decreases at set decel rate until new set speed is reached.
6. Stop Motor and Inverter	Press STOP button.	Motor speed decreases steadily, then motor stops. Meter indication follows motor speed. "RUN" LED blinks.	Inverter output to motor decreases at set decel rate until 1/40 max output level is reached, then DC injection is applied to motor to bring it to a complete stop.
7. Reset Speed to Zero	Turn SPEED pot fully CCW.	No change of indications.	
8. Power Off	Open input circuit breaker.	"RUN" LED goes out. "CHARGE" LED remains illuminated until DC bus capacitor has discharged.	AC input power is immediately removed from the inverter. Charge on DC bus capacitor slowly discharges across bus.

3.3 PRE-OPERATION CONSIDERATIONS

- After completing the initial start-up, connect the motor to the load.
- Adjustments should be made in the inverter to configure the Drive to your specific application. (See Section 4.) Also, additional wiring should be added as required by the selected functions and any options added to or used with the inverter.

3.4 DIGITAL COMMAND BACKUP

When a Digital Operator or Programming Operator is present on the inverter and a control expansion option is also present, the following digital control commands will be stored in the option's NV-RAM memory when the AC input power is removed:

1. Last frequency setting value.
2. AUTO/MAN mode selection.
3. MONI/SET function selection.

When input power is re-applied to the Drive, the above commands are automatically re-entered to the control circuit.

4. INVERTER ADJUSTMENTS

4.1 LOCATION OF ADJUSTMENTS

All internal adjustments for the inverter are located on the Control PC Board and (460V units only) the Voltage Selecting PC Board. The adjustments are listed in Table 7.

4.2 DESCRIPTION OF ADJUSTMENTS

Before making adjustments, shut off AC input power and wait until the "CHARGE" lamp goes out. If any settings, except for accel/decel time, are performed with the power on, the following failure indication will occur:

- Both FAULT lamps (F1 and F2) on the Control PCB blink.
- CPF lamp (or display) if the Analog (or Digital) Operator is used.

If any settings are changed during operation, operation will continue with the settings made before the change. The new settings will not effect operation until the power is removed, and then reapplied.

- The remote Operator Control Station (OCS) provides no failure indication for changing settings with the power ON.

(1) Setting of V/f pattern selector switch (1S)

The V/f pattern selector switch (1S) has been factory-set at notch 6. The customer should select the optimum V/f pattern according to his load characteristics. (See Table 8).

Table 7. List of Inverter Adjustments.









Section A. Control PCB (1 PCB)				
ADJUSTMENT NAME		SYMBOL	FUNCTION	FACTORY-SETTING
V/f Pattern Selector Switch			Selects one of 15 V/f patterns to match specific applications	Notch 1 (See Table 8)
Accel/ Decel Time Setting	Switch		Selects accel/decel time range (0.2 to 1800 seconds).	Notch 1 (See Table 9)
	Potentiometer		Accel/decel times independently adjustable within the time range selected by 2S.	Scale 5
Sequence Mode Selector Switch			Selects one of 15 types of sequences according to application requirements. CAUTION DO NOT TAMPER WITH THIS SWITCH	Notch F
Electronic Thermal Overload Protective Switch			Protects motor and inverter from overcurrent conditions if motor capacity is different from inverter capacity.	Notch F (See Table 10)
Inverter Capacity Selector Switch			Set according to inverter capacity CAUTION DO NOT TAMPER WITH THIS SWITCH	(See Table 11)
Operation Mode Selector Switch			Selects the operation mode according to specific applications.	(See Table 12)
Auto Frequency Reference Signal Selector Shunt			Selects either a current signal (4-20mA) or a voltage signal (0-10V) to feed Auto mode frequency reference signal at terminal 9.	V (Voltage signal)
Manual Frequency Reference Signal			Set to input Manual Mode frequency reference at external terminal 21. When the Analog Operator is used for Frequency setting, set the shunt on "L". The signals from external terminal 21 are not accepted.	R
Section B. Voltage Selecting PC Board (3 PCB) (460V units only)				
Voltage Selector Shunt		See Figure 7	Set according to supply voltage being used.	460V
Radio Noise Reducing Filter Circuit Selector Shunt		See Figure 12	Selects radio noise reducing filter circuit according to application. A. Ground Interrupter not used. B. Ground interrupter used. Shuts off ground circuit and prevents malfunction if the interrupter trips.	A

Table 8. V/f Pattern Selection

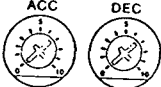
APPLI-CATION	SPECIFICATION		1S NOTCH	V/f PATTERN	APPLI-CATION	SPECIFICATION		1S NOTCH	V/f PATTERN	
GENERAL PURPOSE	50Hz		0		HIGH TORQUE STARTING	50Hz	Starting Torque Low	8		
		Starting Torque High		9						
	60Hz	60Hz Saturation	1			60Hz	Starting Torque Low	A		
		50Hz Saturation		2			Starting Torque High		B	
	72Hz			3			90Hz		C	
	FANS AND PUMPS	50Hz	Variable Torque 2			4				MACHINE TOOLS
Variable Torque 1			5		180Hz		E			
60Hz		Variable Torque 2	6			60Hz		E	E	
		Variable Torque 1		7						

NOTES:

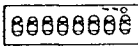
- Take account of the following conditions and others when selecting V/f pattern:
 - Pattern matching the voltage-frequency characteristic of the motor.
 - According to the maximum motor speed.
- V/f pattern for high starting torque should be selected for:
 - Long wiring distance.
 - Large voltage drop at start.
 - AC reactor connected to input or output of the inverter.
 - Use of motor of the rating below the max.
- Patterns shown for 400 V input; for other inputs, multiply all (V) values shown by the factor $(V_{IN}/400)$.

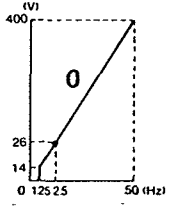
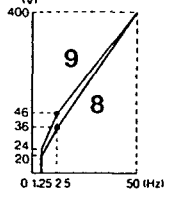
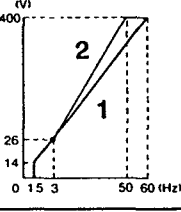
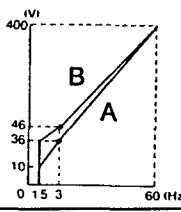
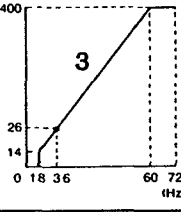
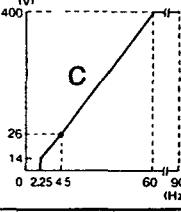
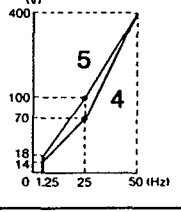
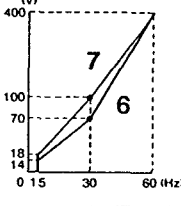
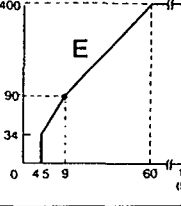
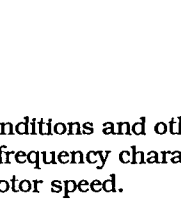
2) Setting of acceleration and deceleration times (2S, ACC, DEC)

Set the acceleration and deceleration times using the time range selector switch (2S) and the acceleration (ACC) and deceleration (DEC) time setting potentiometers. (See Table 9.)

2S has been factory-set to notch 1, and the ACC and DEC potentiometers have been individually set to 50% (approximately 10 seconds).

Table 9. Accel/Decel Time Range Setting

2S NOTCH	ACCEL/DECEL TIME SETTING RANGE (SEC)
0	0.2 - 6
1 (Factory Setting)	1.8 - 18
2	6 - 60
3	18 - 180
4	60 - 600
5 - D	180 - 1800
E	0
F	Temporary setting - For calibrating freq meter

(3) Selection of sequence mode (3S)

The sequence mode selector switch (3S) is factory-set (and paint-locked) to notch F.

(4) Setting of electronic thermal overload setting switch (4S)

Switch 4S is factory-set at notch F. When the motor being used has a capacity different from the maximum applicable capacity of the inverter, this setting can be changed to better protect the motor. For details, refer to Table 10.

5) Selection of inverter capacity (5S)

Switch 5S has been factory-set to agree with the inverter capacity as shown in Table 11. DO NOT CHANGE.

Table 10. System Control With Typical Standard 4 Pole Motor

SECTION A. 230V UNITS						
INVERTER HP RATING	MOTOR HP	4S SETTING	MOTOR HP	4S SETTING	MOTOR HP	4S SETTING
5	5	6	3	3	2	1
7.5	7.5	6	5	3	3	1
10	10	6	7.5	3	5	1
15	15	6	10	3	7.5	1
20	20	6	15	3	10	0
25	20	6	15	3	10	0
30	25	6	20	3	15	2
40	30	6	25	3	20	1
50	40	6	30	3	25	1
60	50	6	40	3	30	1
75	60	6	50	3	40	1
100	75	6	60	3	50	1
125	100	6	75	3	60	1

Table 10. System Control With Typical Standard 4 Pole Motor (Continued)

SECTION B. 460V UNITS						
INVERTER HP RATING	MOTOR HP	4S SETTING	MOTOR HP	4S SETTING	MOTOR HP	4S SETTING
5	5	6	3	3	1	1
7.5	7.5	6	5	3	3	1
10	10	6	7.5	4	5	1
15	15	6	10	3	7.5	1
20	15	6	10	3	7.5	1
25	20	6	15	3	10	0
30	25	6	20	3	15	1
40	30	6	25	3	20	1
50	40	6	30	3	25	1
60	50	6	40	3	30	1
75	60	6	50	3	40	1
100	75	6	60	3	50	1
150	100	6	75	3	60	1
200	150	6	100	3	75	1
250	—	—	150	3	100	1
300	200	6	150	1	—	—
350	300	6	200	3	—	—
400	300	6	250	3	—	—
500	400	6	—	—	—	—

Table 11. Inverter Capacity Selection

INVERTER HP	INPUT VOLTS	5S SETTING
5, 7.5	230, 460	3
10, 15	230, 460	4
20	460	
20	230	5
25, 30	230, 460	
40	230, 460	6
50, 60	230, 460	7
75	230, 460	8
100	460	
100	230	9
125	230	A
150	460	B
200	460	D
250	460	E
300, 350, 400	460	F
450, 500, 600	460	

(6) Selection of operation modes (6S)

Select the operation modes from Table 12 according to the application, and set each notch of switch 6S as indicated.

NOTE

For 460V units, notches 1 thru 7 have been factory-set to OFF and 8 to ON. For 230V units, notches 1 thru 8 have been factory-set to OFF.

When changing settings, switches must be treated delicately.

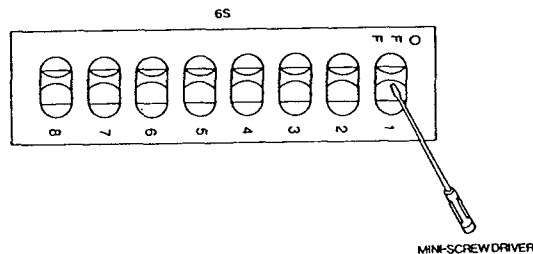

Figure 9. Switch 6S

Table 12. Selection of Operation Modes

6S NOTCH	FEATURES	DESIRED OPERATION	ON	OFF
1	DC INJECTION AT STOP	DC INJECTION IS APPLIED AFTER CONTROLLED DECELERATION TO 1/40 OF MAXIMUM SPEED.		X
		MOTOR COASTS BELOW 1/40 OF MAXIMUM SPEED.	X	
2	STOPPING MOTOR	CONTROLLED DECELERATION ON INVERTER AS PER NOTCH 1.		X
		COAST TO STOP.	X	
3	BRAKING RESISTORS	DYNAMIC BRAKE OPTION IS NOT USED.		X
		DYNAMIC BRAKE OPTION IS USED.	X	
4	DC INJECTION AT START	DC INJECTION BEFORE STARTING (ANTI-WINDMILLING) FOR 1/5 OF SET DECEL TIME.	X	
		NORMAL ACCELERATION OPERATION.		X
5	POWER FAILURE RIDE-THRU	MOTOR COASTS TO STOP AFTER MOMENTARY POWER FAILURE.		X
		MOTOR CONTINUES OPERATION IF POWER FAILURE IS LESS THAN 2 SECONDS, OR COASTS TO A STOP IF FAILURE IS GREATER THAN 2 SECONDS.	X	
6	SPEED SEARCH *	ABILITY TO START INTO A COASTING MOTOR (SPEED SEARCH). <u>IMPORTANT</u> - NOTCH 5 MUST BE ON.		X
		SPEED SEARCH OVER-RIDE.	X	
7	JOGGING**	SOFT JOG OPERATION TO 1/10 SPEED.	X	
		NORMAL JOG OPERATION AT 1/10 SPEED.		X
8***	RATED SUPPLY VOLTAGE	230V		X
		460V	X	

* Drive output frequency is synchronized with motor speed, then motor is accelerated back to set speed.

** Only used with either Digital or Analog Operator option.

*** DO NOT CHANGE.

(7) Selection of Auto mode frequency reference signal

Input terminal 9 will accept either a current signal (4 to 20mA) or a voltage signal (0 to 10VDC).

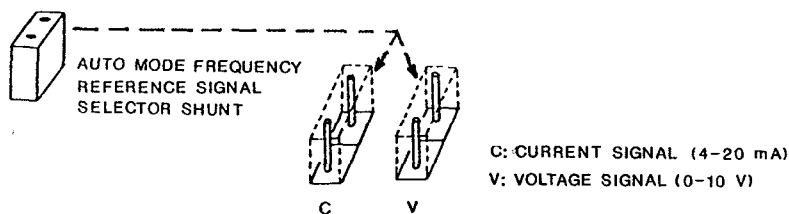

Figure 10. Master Frequency Reference Signal Selection

(8) Selection of Manual mode frequency reference signal

When the shunt is in the (R) position, terminal 21 can be used as a frequency reference input. If the shunt is in the (L) position, terminal 21 will not be operable.

The shunt is factory-set to (R) and must be changed to the (L) position when installing the Analog Operator option.

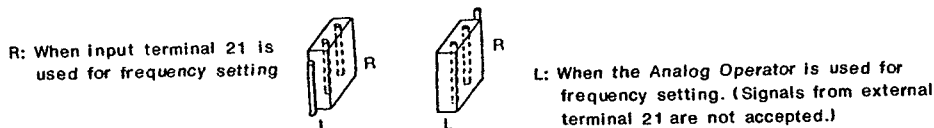

Figure 11. Manual Frequency Reference Signal Selection

(9) Selection of radio noise reducing filter circuit (460 volt units only)

The RF noise filter is factory set to the "ON" position. Its function is to reduce the amount of RF noise that can be emitted by the inverter.

NOTE

When a separate ground fault interrupter is used, this circuit should be changed to the "OFF" position to prevent false tripping.

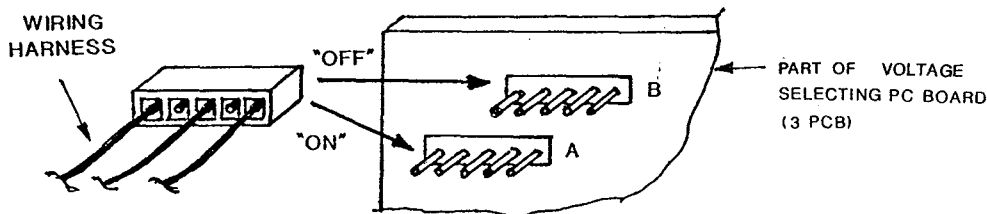

Figure 12. Radio Noise Filter Circuit Shunt

5. OPERATION AT LOAD

After inverter adjustments have been made and all control wiring is completed, verify that the driven machine is in running condition, and that no dangerous conditions exist around the drive system.

OPERATING PRECAUTIONS

- Before applying a RUN command to the inverter, verify that the motor is stopped. If the application requires the capability of restarting a coasting motor, the inverter must be set for either DC injection at start (switch 6S notch 4 set to ON) OR speed search (switch 6S notch 6 set to ON).
- When a standard motor is used with the inverter, there is some increase of motor temperature, noise and vibration as compared to line operation.
- The motor cooling effect decreases during low-speed running. The torque needs to be reduced in accordance with the frequency. For the reduction ratio, refer to the motor catalog or technical sheet.
- Even with small loads, never use a motor whose current exceeds the inverter rating.
- When two or more motors are operated by one inverter, verify that the total motor current is not larger than the inverter rating.
- When starting and stopping the motor, use the operation signals (RUN/STOP), NOT the magnetic contactor on the power supply side.

Run the motor under load in a manner similar to the initial start-up (Table 6). The operation procedures must be altered according to the completed control wiring.

For preset starting (one-touch operation after setting the frequency) when a Digital or Programming Operator is used, perform the following:

1. Set the frequency and press RUN button to start the motor and accelerate it (at the rate corresponding to the preset ACCEL) to the preset frequency. The acceleration time is set too short relative to the load if the RPM of the accelerating motor does not increase smoothly (stall prevention during acceleration is functioning) or if a fault code is displayed.
2. Press STOP button to decelerate the motor (at the rate corresponding to the preset DECEL) to a stop. The deceleration time is set too short relative to the load if the RPM of the decelerating motor does not decrease smoothly (stall prevention during deceleration is functioning) or if a fault code is displayed.

6. MAINTENANCE

The inverter requires almost no routine checks. It will provide efficient and reliable service if it is kept clean, cool and dry, observing precautions listed in Section 2.1A. Check for tightness of electrical connections, component discoloration or other signs of overheating. Use Table 13 as the inspection guide.

CAUTION

**BEFORE INSPECTING, TURN OFF THE AC INPUT POWER
AND ALLOW THE "CHARGE" LAMP TO GO OUT.**

Table 13. Periodic Inspection.

COMPONENT	CHECK	CORRECTIVE ACTION
EXTERNAL TERMINALS, UNIT MOUNTING BOLTS, CONNECTORS, ETC.	LOOSE SCREWS.	TIGHTEN
	LOOSE CONNECTORS.	TIGHTEN
HEAT SINK COOLING FINS	BUILD-UP OF DUST AND DIRT.	CLEAN WITH DRY COMPRESSED AIR (15 TO 30 PSI).
PRINTED CIRCUIT BOARDS	FOR BUILD-UP OF CONDUCTIVE DUST AND OIL MIST.	CLEAN THE BOARD. IF DUST AND OIL CANNOT BE REMOVED, REPLACE THE BOARD.
	DISCOLORATION DUE TO HEAT.	REPLACE THE BOARD.
POWER ELEMENTS	ACCUMULATION OF DUST AND DIRT.	CLEAN WITH DRY COMPRESSED AIR (15 TO 30 PSI).
FILTER CAPACITOR	DISCOLORATION OR ODOR.	REPLACE THE CAPACITOR.

7. FAILURE INDICATION AND DETAILS

A failure, when detected, will shut off the output power transistors and output a FAULT signal by contact closure at inverter terminals 14, 15, and 16.

When an Analog or Digital Operator is used, failure indications listed in Table 14 will function; otherwise failure conditions are shown by the two FAULT lamps (F1 and F2) on the Control PCB in the inverter, as listed in Table 15.

Table 14. Failure Indication with an Analog or Digital Operator.





















INDICATION *	CAUSE
UV** OR (UU ***) (UNDERVOLTAGE)	DC BUS VOLTAGE LOWER THAN APPROXIMATELY 450V FOR 460V UNITS, 225V FOR 230V UNITS.
OV OR (OU ***) (OVERVOLTAGE)	DC BUS VOLTAGE HIGHER THAN APPROXIMATELY 790V FOR 460V UNITS, 395V FOR 230V UNITS.
OC (OVERCURRENT)	200 PERCENT OF RATED CURRENT WAS EXCEEDED. (INSTANTANEOUS OPERATION)
OL (OVERLOAD)	OVERLOAD OF MOTOR AND INVERTER DETECTED BY ELECTRONIC THERMAL CIRCUIT.
OH (HEAT SINK OVERHEAT)	THERMOSWITCH OPERATED BY OVERHEATING OF MAIN CIRCUIT SEMICONDUCTOR HEAT SINK.
CPF (CONTROL FUNCTION ERROR)	DETECTION OF CPU FAILURE OR MAIN CONTROL MALFUNCTION BY SELF-DIAGNOSTIC FUNCTION.
EB (OR Eb ***) (EXTERNAL FAULT)	EXTERNAL FAULT SIGNAL INPUT AT INVERTER TERMINAL 7.
FU (BLOWN FUSE)	MAIN CIRCUIT FUSE BLOWN.

* FAULT will be displayed with individual failure indication on the screen of Digital Operator.

** Operation continues after a momentary power failure when notch 5 of switch 6S is ON; UV lamp or display flashes for approximately two seconds.

*** For Digital Operator display.

Table 15. Failure Indication on Control PCB.

INDICATION		CAUSE
F1	F2	
		FU (FUSE BLOWN): MAIN CIRCUIT FUSE BLOWN.
		OC (OVERCURRENT): MORE THAN 200 PERCENT OF RATED CURRENT WAS REQUIRED.
		OC (OVERLOAD): ELECTRONIC THERMAL CIRCUIT DETECTED MOTOR AND INVERTER OVERLOAD.
		OV (OVERVOLTAGE): DC BUS VOLTAGE HIGHER THAN 790V FOR 460V UNITS, 395 FOR 230V UNITS.
		UV1 (UNDERVOLTAGE): DC BUS LOWER THAN SPEC. WITH 6S-5 SET TO ON. (BLINKS FOR 2 SEC.)
		UV2 (UNDERVOLTAGE): DC BUS LOWER THAN 450V FOR 460V UNITS, 225V FOR 230V UNITS.
		OH (OVERHEAT): THERMOSWITCH ON SEMICONDUCTOR HEAT SINK DETECTED EXCESSIVE TEMPERATURE.
		EB (EXTERNAL FAULT): EXTERNAL FAULT SIGNAL INPUT AT INVERTER TERMINAL 7.
		CPF (CONTROL FUNCTION ERROR): CPU FAILURE.
		CPF-SEL (SELECTION ERROR): SWITCH 1S THRU 6S CHANGED WITH POWER ON.

NOTE: INDICATION STATUS IS AS FOLLOWS:



LIGHT OFF.



BLINKING AT EQUAL INTERVALS.



BLINKING AT SHORT-LONG INTERVALS.



LIGHT ON STEADY.

8. TROUBLESHOOTING

If the unit malfunctions, locate the cause and take corrective action by following the flowcharts given in this section.

A. TROUBLESHOOTING MOTOR SYMPTOMS

Motor Will Not Run	Chart 8.1
Motor Stalls During Acceleration.....	Chart 8.2

B. TROUBLESHOOTING FAULT CONDITIONS

Overvoltage (OV)	Chart 8.3
Blown Fuse (FU).....	Chart 8.3.1
Overcurrent (OC).....	Chart 8.4
Overload (OL).....	Chart 8.5
Undervoltage (UV)	Chart 8.6
Inverter Overheated (OH).....	Chart 8.7
Control Function Error (CPF)	Chart 8.8
Fault Signal Input (EB)	Chart 8.9

Since the Inverter utilizes the PWM control mode, specified instruments must be used for correct measurements.

The measuring points and types of instruments are shown in Table 16 and Figure 13.

WARNING

OSCILLOSCOPE CHASSIS MAY BE AT VOLTAGES POTENTIALLY HAZARDOUS TO LIFE IF NOT PROPERLY GROUNDED. IF OSCILLOSCOPE IS USED TO MEASURE HIGH VOLTAGE WAVEFORMS, USE ONLY A DUAL CHANNEL OSCILLOSCOPE IN THE DIFFERENTIAL MODE WITH X100 PROBES. ALWAYS CONNECT OSCILLOSCOPE CHASSIS TO EARTH GROUND.

WARNING

VOLTAGES DANGEROUS TO LIFE EXIST WHEN EQUIPMENT IS OPEN AND ENERGIZED. DO NOT WORK ALONE.

CAUTION

TO PREVENT EQUIPMENT DAMAGE ALWAYS REMOVE INCOMING THREE-PHASE POWER BEFORE TEST EQUIPMENT IS CONNECTED OR REMOVED.

Table 16. Measuring Points and Instruments.

ITEM	POINTS	INSTRUMENTS	NOTE
SUPPLY VOLTAGE	L1-L2 L2-L3 L3-L1	VOLTMETER: RECTIFIER OR MOVING IRON TYPE	
SUPPLY CURRENT	L1, L2 L3	AMMETER: MOVING IRON TYPE	
SUPPLY POWER	W(L1), W(L2), W(L3)	WATTMETER: ELECTRODYNAMOMETER TYPE (INCORPORATING A HALL GENERATOR)	$P1 = W(L1) + W(L2) + W(L3)$
OUTPUT VOLTAGE	T1-T2 T2-T3 T3-T1	VOLTMETER: RECTIFIER TYPE ONLY	1000V SCALE (460V) 500V SCALE (230V)
OUTPUT CURRENT	T1, T2 T3	AMMETER: MOVING IRON TYPE	
OUTPUT POWER	W(T1), W(T2), W(T3)	WATTMETER: ELECTRODYNAMOMETER	$P2 = W(T1) + W(T2) + W(T3)$
FREQUENCY SETTING SIGNAL	9(+) TO 10 21(+) TO 22	VOLTMETER: MOVING-COIL TYPE INTERNAL RESISTANCE 50K OHM MAXIMUM	0 TO 10 VDC
FREQUENCY MONITOR	17(+) TO 18		10 VDC AT MAX SPEED AND UNLOADED

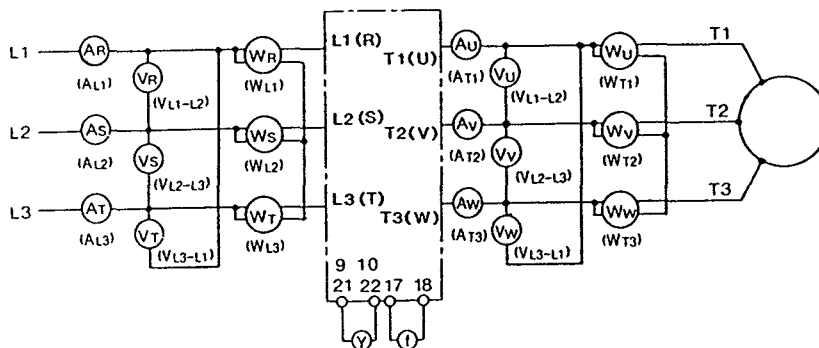

Figure 13.

Figure 14 shows an example of actually measured output voltage. The rectifier type instruments may give different readings depending on the type used.

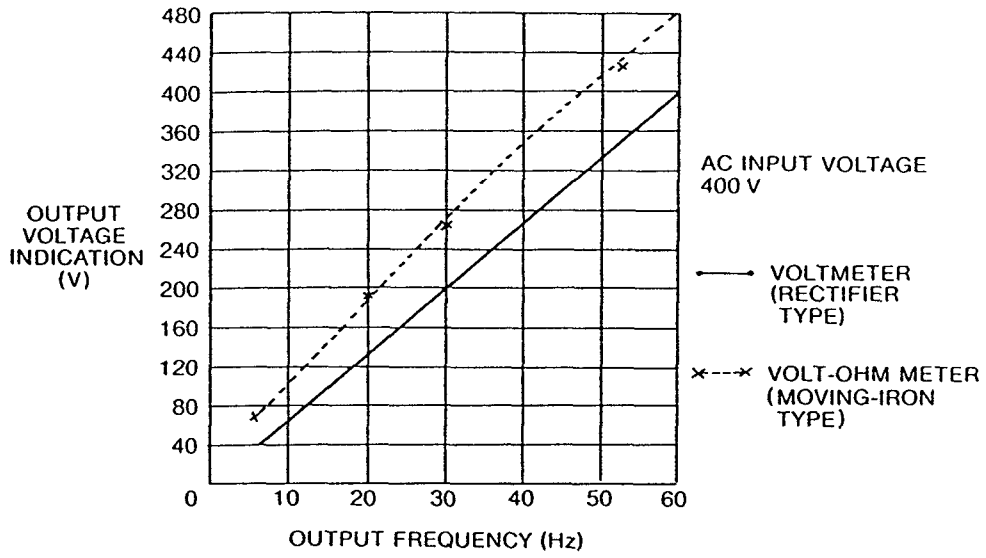
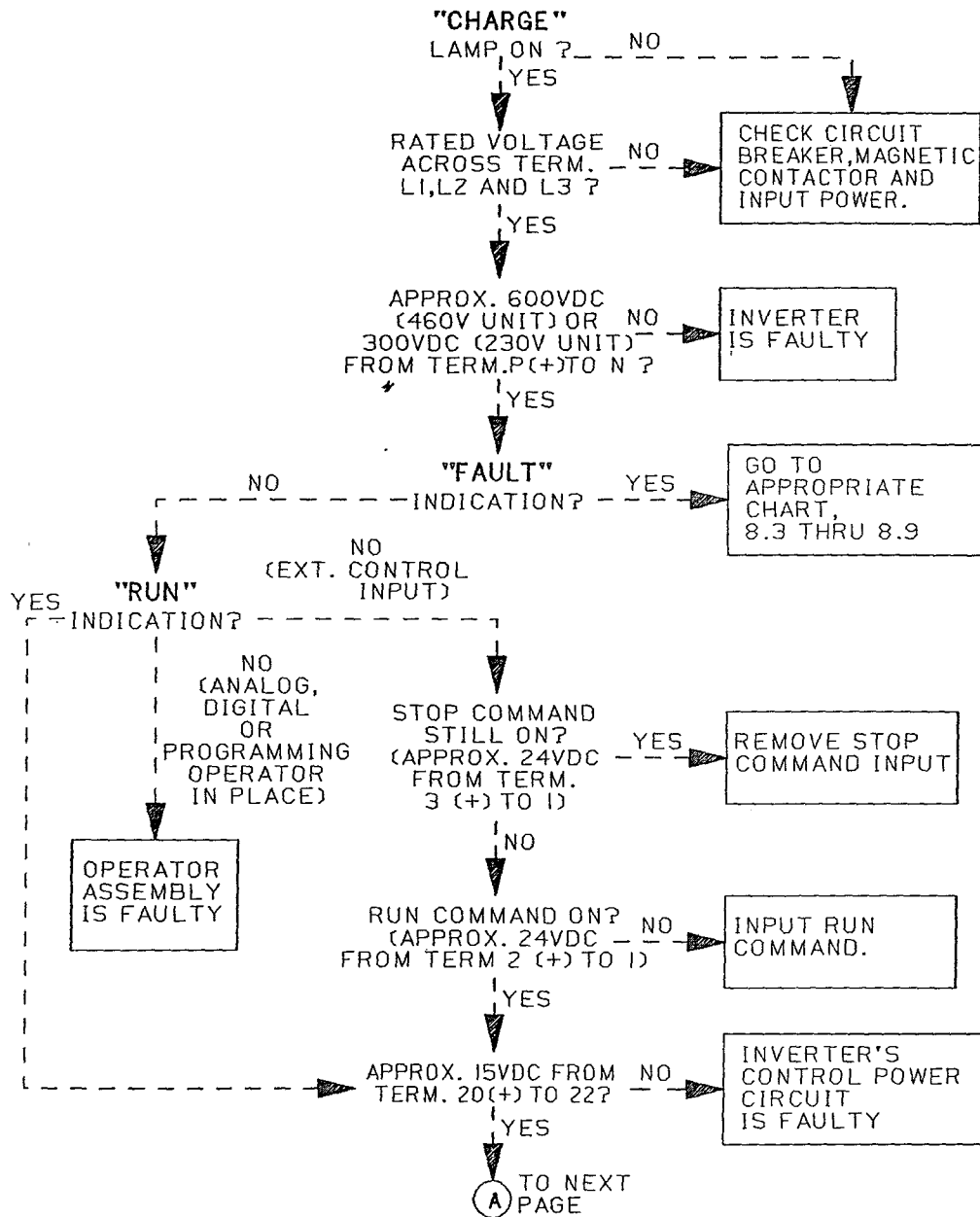

Figure 14.

TROUBLESHOOTING CHART 8.1

MOTOR WILL NOT RUN



TROUBLESHOOTING CHART 8.1 (Continued)

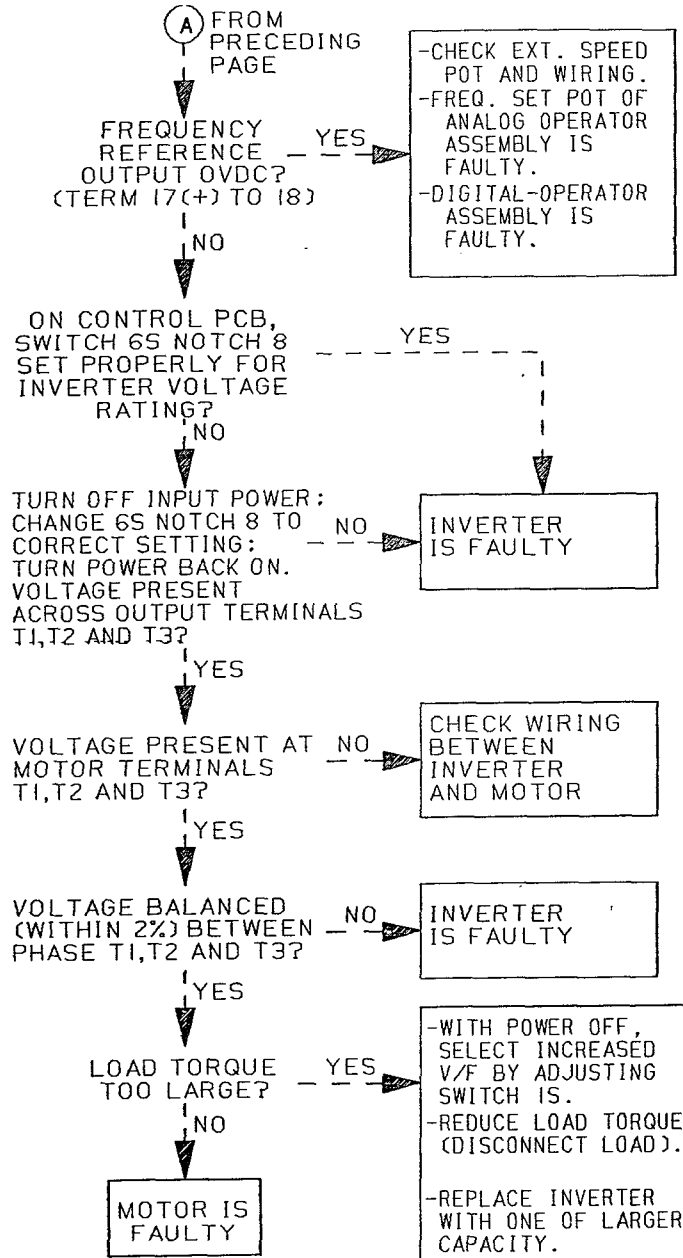

TROUBLESHOOTING CHART 8.2

MOTOR STALLS DURING ACCELERATION

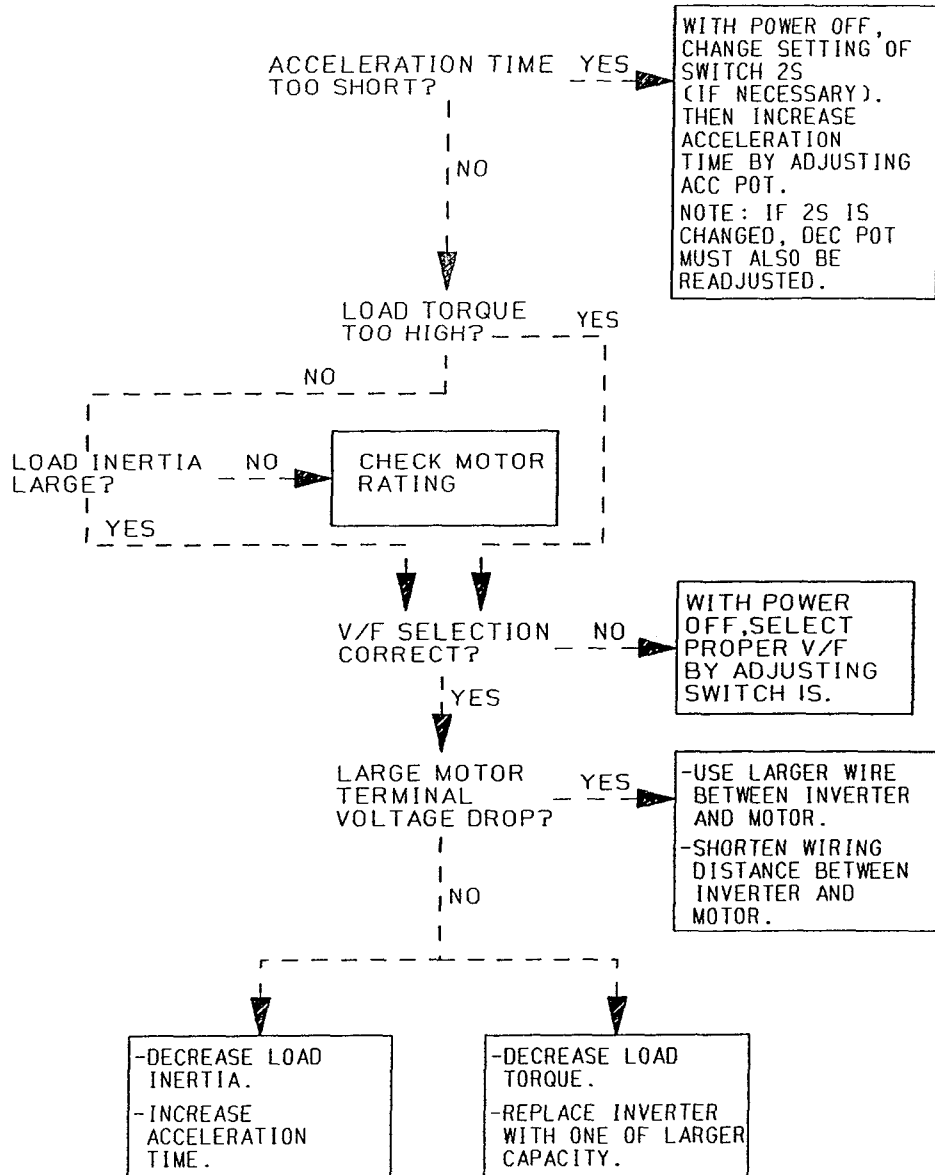

TO I 6P0602.C8.2

TROUBLE SHOOTING CHART 8.3

OVERVOLTAGE (OV OR OU) FAULT INDICATION

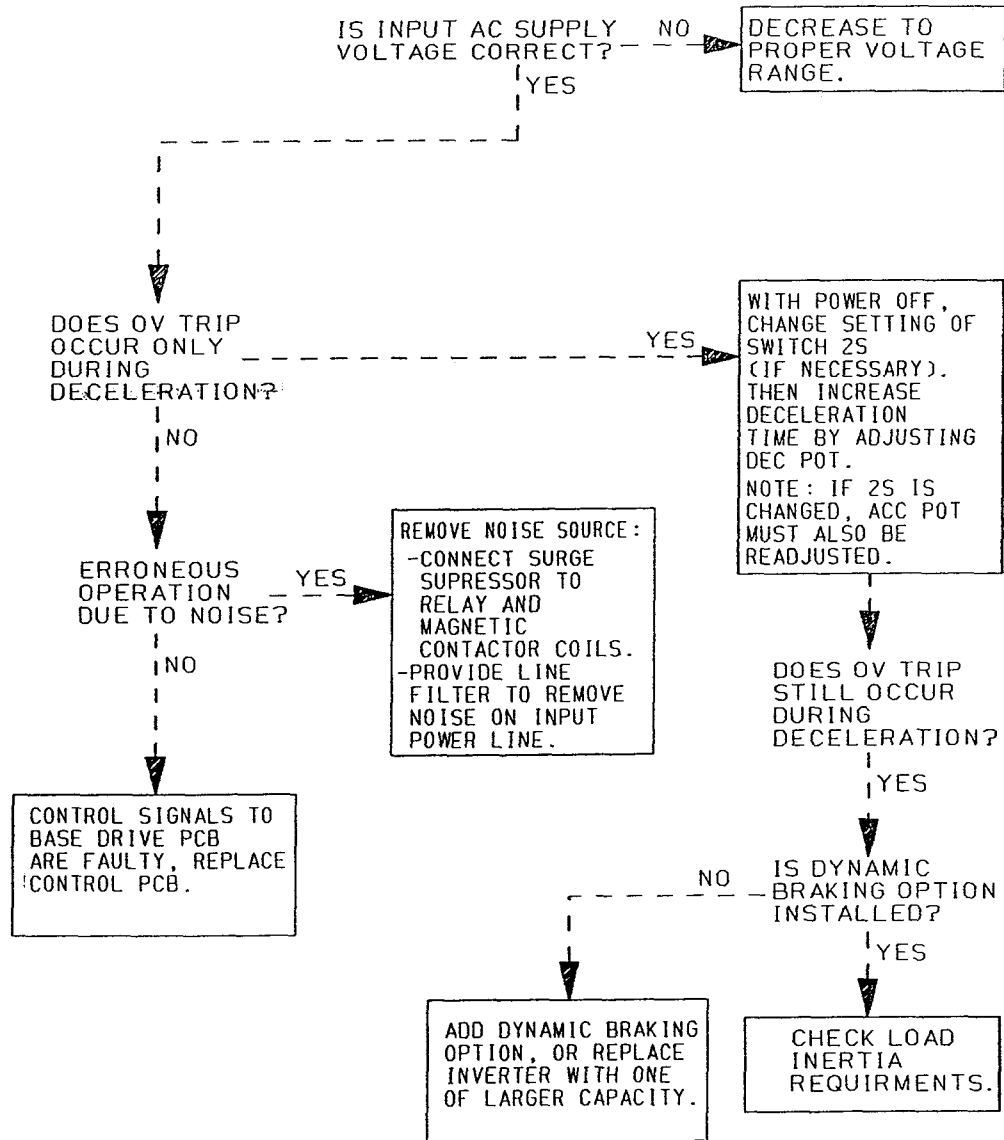

TD1.GP0602.C8.3

TROUBLESHOOTING CHART 8.3.1

BLOWN FUSE (FU) FAULT INDICATION

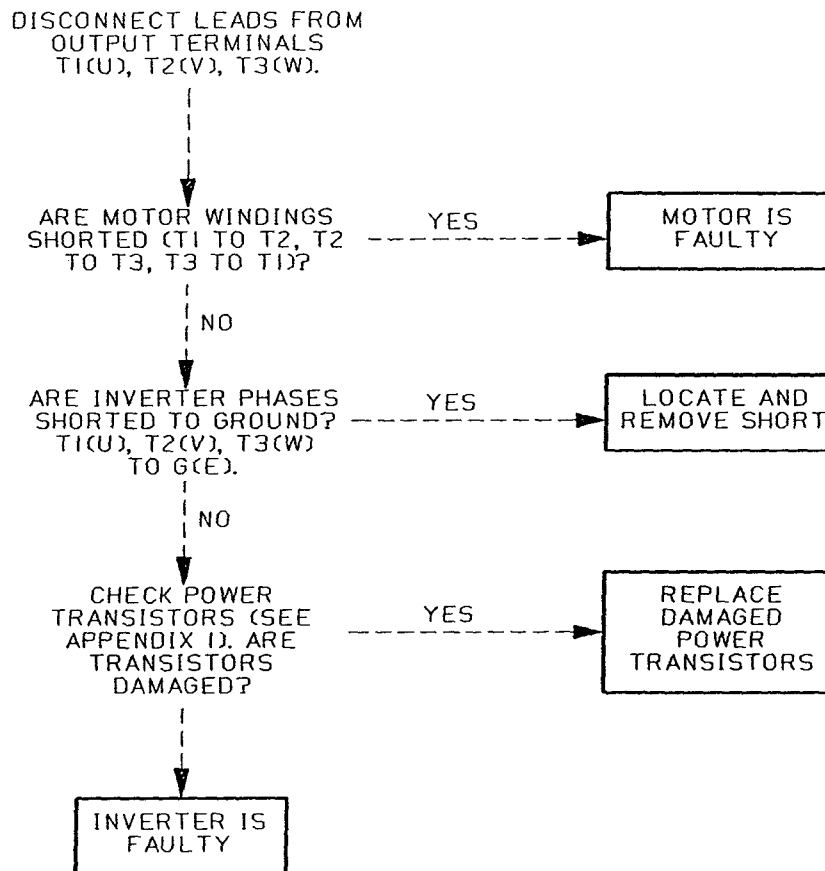

TD.1.GPD602.C8.3.1

TROUBLESHOOTING CHART 8.4

OVERCURRENT (OC) FAULT INDICATION

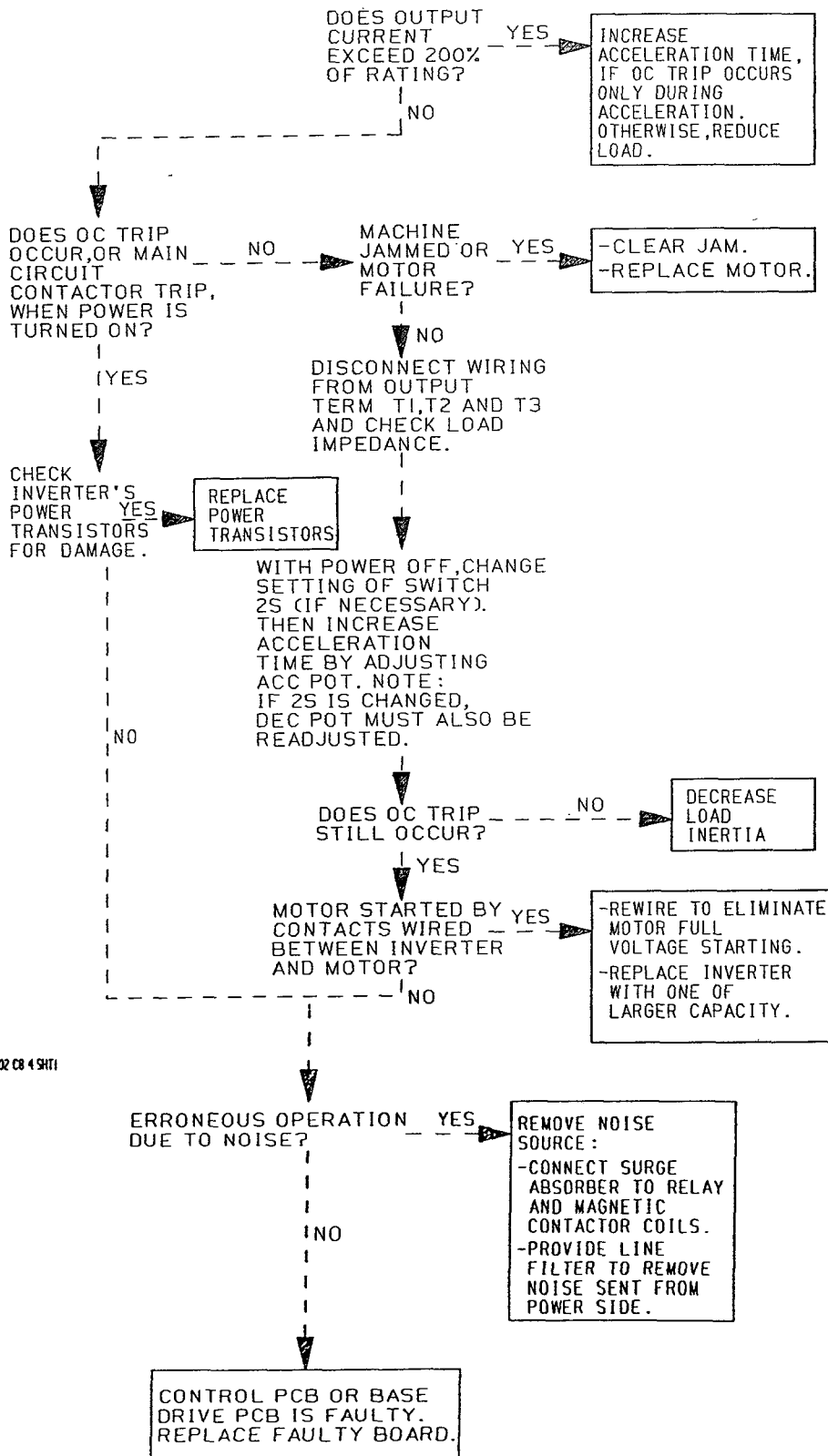

TD.1.GP0602 CB 4.5HT1

TD.1.GP0602 CB 4.5HT2

TROUBLESHOOTING CHART 8.5

OVERLOAD (OL) FAULT INDICATION

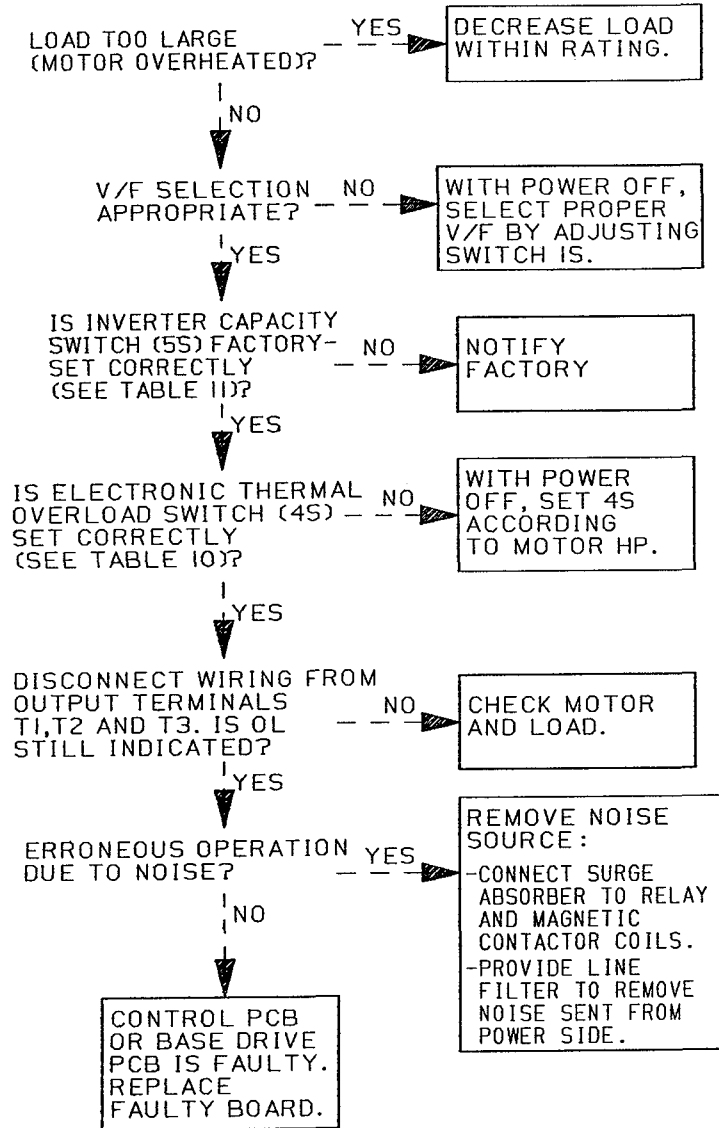

TROUBLESHOOTING CHART 8.6

UNDERVOLTAGE (UV OR UU) FAULT INDICATION

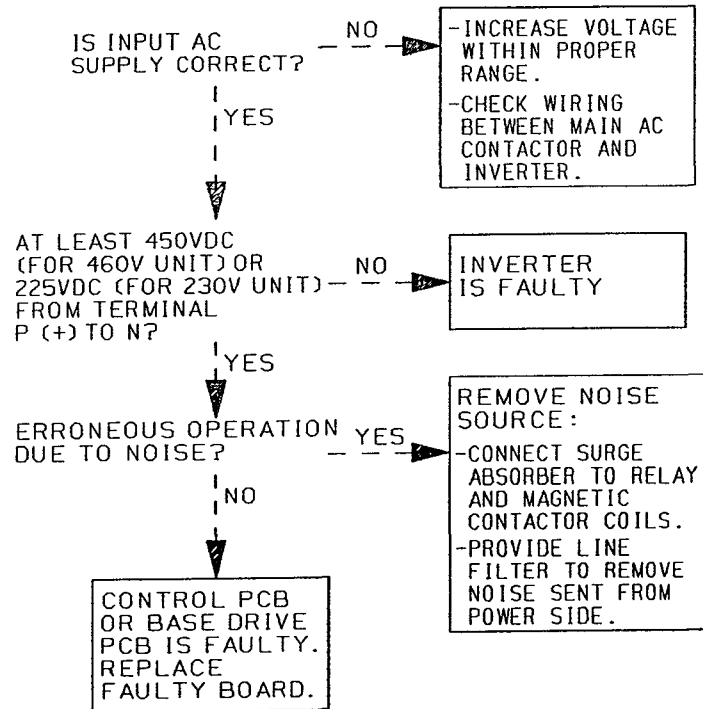

TROUBLESHOOTING CHART 8.7

INVERTER OVERHEATED (OH) FAULT INDICATION

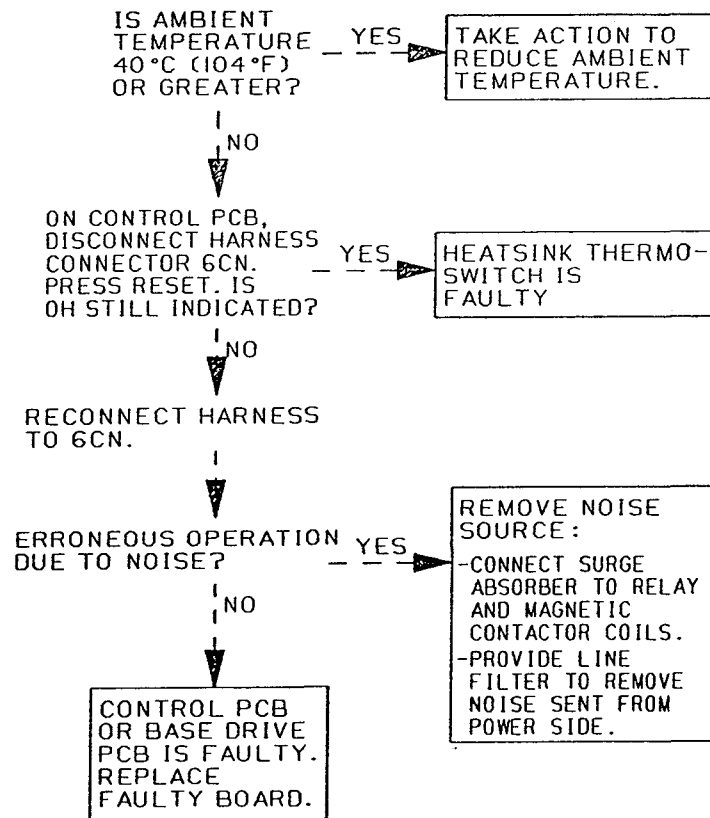

TROUBLESHOOTING CHART 8.8

CONTROL FUNCTION ERROR (CPF) FAULT INDICATION

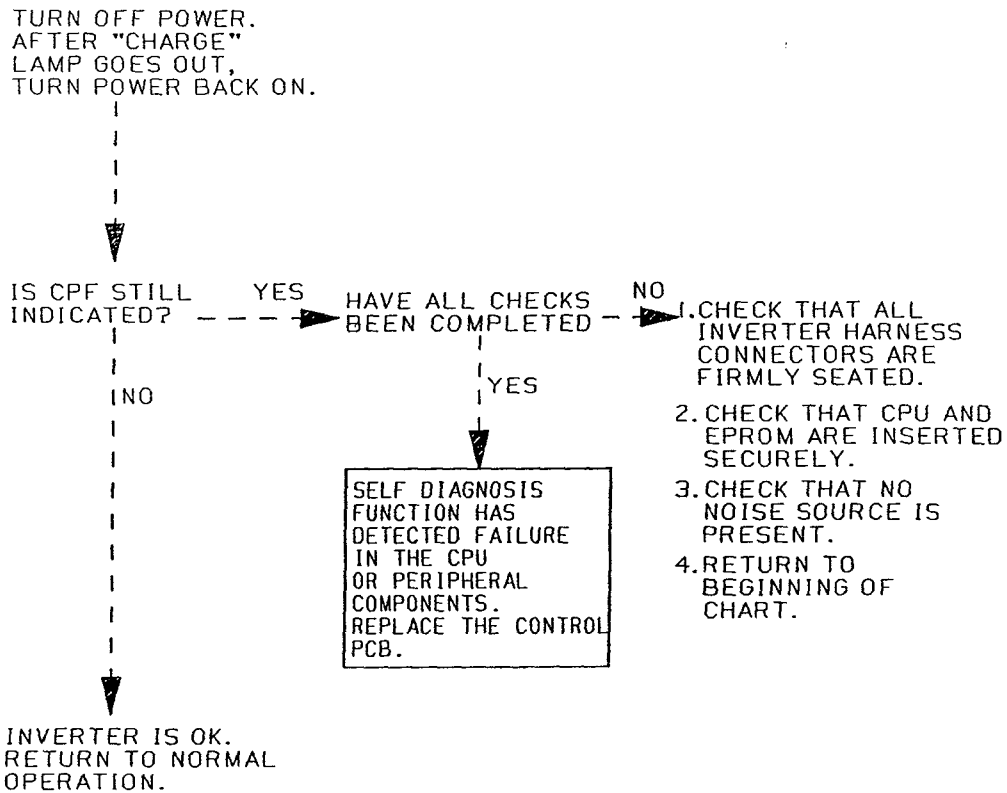

TD 1.GP0602 C8 8

TROUBLESHOOTING CHART 8.9

EXTERNAL FAULT (EB OR Eb) INDICATION

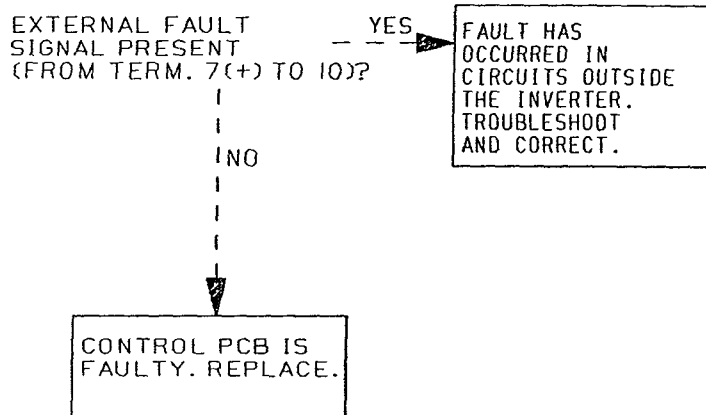

TD 1.GP0602 C8 9

APPENDIX 1. CHECKING OF DIODE AND TRANSISTOR MODULES

Diode Module

Measure the resistance across the module terminals with a volt-ohm meter. Set the meter at the X1 range. The measured resistance should be within the reference values listed in Table 17.

Table 17. Diode Module Resistances

+	-	NORMAL READING (OHMS)	ABNORMAL READING (OHMS)
ON	ON		
L1	P	10 TO 50	0 OR INF
L2	P		
L3	P		
N	L1		
N	L2		
N	L3		

+	-	NORMAL READING (OHMS)	ABNORMAL READING (OHMS)
ON	ON		
L1	N	INFINITE	LESS THAN
L2	N		
L3	N		
P	L1		
P	L2		
P	L3		
P	N	MAGNITUDE OF CAP CHARGE TO INF	0 OR INF

RESISTANCE TEST FOR 3Ø DIODE MODULES (BRIDGE RECT)

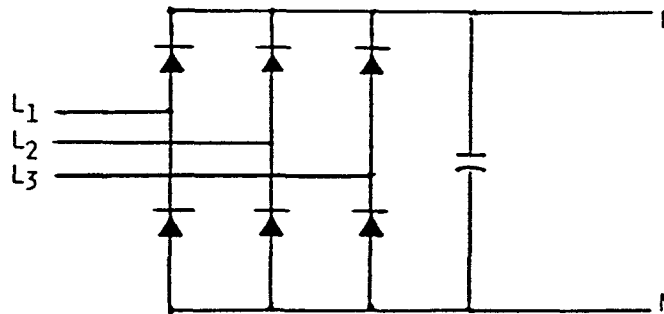

VOM RESISTANCE SCALE RX1
 + IS THE POSITIVE POLARITY LEAD*
 - IS THE NEGATIVE POLARITY LEAD

*THE VOM RED LEAD IS NOT NECESSARILY THE POSITIVE POTENTIAL IN THE RESISTANCE MODE. FOR THESE TESTS THE + LEAD REFERS TO THE POSITIVE POTENTIAL. MAKE SURE YOU KNOW WHICH POLARITY YOU HAVE ON YOUR VOM.

Transistor Module

Measure the resistance across the module terminals with a volt-ohm meter. Set the meter at the X1 range. The measured resistance should be within the reference values listed in Table 18.

Table 18. Transistor Module Resistances

+	-	NORMAL READING (OHMS)	ABNORMAL READING (OHMS)
ON	ON		
P P P A B C	A B C N N N	GREATER THAN 50 K	0
A B C N N N	P P P A B C	10 TO 50	0 OR INF

+	-	NORMAL READING (OHMS)	ABNORMAL READING (OHMS)
ON	ON		
B1A B1B B1C B2A B2B B2C	A B C D D D	10 TO 50	GREATER THAN 10KΩ
A B C N N N	B1A B1B B1C B2A B2B B2C	200 TO 5K	0 OR INF

RESISTANCE TEST FOR 3Ø TRANSISTOR MODULES

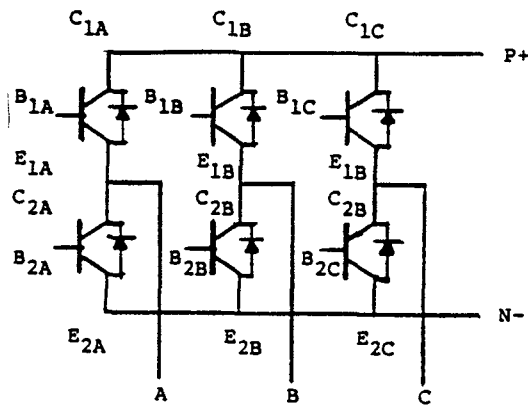

VOM RESISTANCE SCALE RX1
 + IS THE POSITIVE POLARITY LEAD*
 - IS THE NEGATIVE POLARITY LEAD

*THE VOM RED LEAD IS NOT NECESSARILY THE POSITIVE POTENTIAL IN THE RESISTANCE MODE. FOR THESE TESTS THE + LEAD REFERS TO THE POSITIVE POTENTIAL. MAKE SURE YOU KNOW WHICH POLARITY YOU HAVE ON YOUR VOM.

APPENDIX 2. SPARE PARTS

It is recommended that the customer stock on-site spare parts to minimize costly down time. Table 19 lists parts which have a high probability of needing replacement.

Table Entry XXXXXXXX-XX (X)

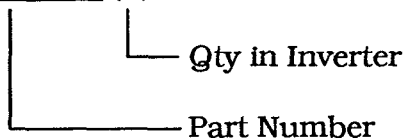

Table 19. Recommended Spart Parts

Section A. Wall-Mount Units			
230V		460V	
HP	DC BUS FUSE	HP	DC BUS FUSE
15	501739-36 (1)	5	501739-24 (1)
20, 25	501739-37 (1)	7.5, 10	501739-19 (1)
30	501739-38 (1)	15, 20, 25	501739-20 (1)
40	501739-39 (1)	30, 40	501739-09 (1)
50	501739-40 (1)	50	501739-10 (1)
60	501739-41 (1)	60, 75	501739-11 (1)
75	501739-42 (1)	100	501739-12 (1)
—	—	150	501739-13 (1)
—	—	200	501739-98 (1)

Section B. 230V Floor Standing	
HP	DC BUS FUSE
100,125	501739-43 (1)

Table 19. Recommended Spart Parts (Continued)

Section C. 460V Floor Standing			
HP	INPUT POWER FUSE	DC BUS FUSE	FAN FUSE
200,300	501739-99 (2)	501739-65 (1)	FU000597 (2)
350	501739-99 (2)	501739-93 (1)	
450	501739-74 (2)	501739-75 (1)	
500,600	501739-76 (2)	501739-77 (1)	